



*An Online PDH Course
brought to you by
CEDengineering.com*

An Introduction to Cathodic Protection Inspection and Testing

Course No: E05-007

Credit: 5 PDH

J. Paul Guyer, P.E., R.A., Fellow ASCE, Fellow AEI



Continuing Education and Development, Inc.

P: (877) 322-5800

info@cedengineering.com

www.cedengineering.com

This course was adapted from the Unified Facilities Criteria of the United States government, which is in the public domain.

CONTENTS

- 1. INSPECTION PROCEDURES AND CRITERIA**
- 2. APPLICABILITY**
- 3. CRITERIA**
- 4. OTHER CONSIDERATIONS**
- 5. ALTERNATIVE REFERENCE ELECTRODES**
- 6. TESTING**

1. INSPECTION PROCEDURES AND CRITERIA

1. INTRODUCTION. This discussion includes criteria and inspection actions that, when used either separately or in combination, will indicate whether adequate cathodic protection of a metallic piping system has been achieved.

1.1 METHODS. The effectiveness of cathodic protection or other corrosion control measures can be affirmed by visual observation, measurements of pipe wall thickness, or by use of internal inspection devices. Because such methods sometimes are not practical, meeting any criterion or combination of criteria in this chapter is evidence that adequate cathodic protection has been achieved. When excavations are made for any purpose, the pipe should be inspected for evidence of corrosion and/or coating condition. Apply sound engineering practices to determine the methods and frequency of testing required to satisfy these criteria.

1.1.1 THE CRITERIA in this discussion have been developed through laboratory experiments and/or verified by evaluating data obtained from successfully operated cathodic protection systems. Situations may exist where a single criterion for evaluating the effectiveness of cathodic protection may not be satisfactory for all conditions. Often a combination of criteria is needed for a single structure.

1.1.2 CORROSION LEAK HISTORY is valuable in assessing the effectiveness of cathodic protection. Corrosion leak history by itself, however, must not be used to determine whether adequate levels of cathodic protection have been achieved unless it is impractical to make electrical surveys.

2. APPLICABILITY. This recommended practice is intended to serve as a guide for establishing minimum requirements for control of corrosion on the following systems:

2.1 NEW PIPING SYSTEMS. Corrosion control by coating supplemented with cathodic protection, or by some other proven method, should be provided in the initial design and maintained during the service life of the piping system, unless investigations indicate that corrosion control is not required. Consideration should be given to the construction of pipelines in a manner that facilitates the use of in-line inspection tools.

2.2 EXISTING COATED PIPING SYSTEMS. Cathodic protection should be provided and maintained, unless investigations indicate that cathodic protection is not required.

2.3 EXISTING BARE PIPING SYSTEMS. Studies should be made to determine the extent and rate of corrosion on existing bare piping systems. When these studies indicate that corrosion will affect the safe or economic operation of the system, adequate corrosion control measures should be taken. Special conditions sometimes exist where cathodic protection is ineffective or only partially effective. Such conditions may include elevated temperatures, disbonded coatings, thermal insulating coatings, shielding, bacterial attack, and unusual contaminants in the electrolyte. Deviation from the recommended practice may be warranted in specific situations provided that corrosion control personnel in responsible charge are able to demonstrate that the objectives expressed in the recommended practice have been achieved.

3. CRITERIA. The criteria described below are in accordance with the following National Association of Corrosion Engineers (NACE) standards:

- RP0169, *Corrosion Control of External Corrosion on Underground or Submerged Metallic Piping Systems*
- RP0285, *Corrosion Control of Underground Storage Tanks By Cathodic Protection*
- RP0388, *Impressed Current Cathodic Protection of Internal Submerged Surfaces of Steel Water Storage Tanks*
- RP0193, *External Cathodic Protection of On-Grade Metallic Storage Tank Bottoms*
- RP0196, *Galvanic Anode Cathodic Protection of Internal Submerged Surfaces of Steel Water Storage Tanks*

Personnel responsible for corrosion control are not limited to criteria in this discussion. Criteria that have been successfully applied on existing piping systems can continue to be used on those piping systems. Any other criteria used must achieve corrosion control comparable to that attained with the criteria within this chapter.

3.1 STEEL AND CAST IRON PIPING. Corrosion control can be achieved at various levels of cathodic polarization depending on the environmental conditions. However, in the absence of specific data that demonstrate that adequate cathodic protection has been achieved, one or more of the following shall apply:

3.1.1 A NEGATIVE (CATHODIC) POTENTIAL of at least 850 mV with the cathodic protection applied. This potential is measured with respect to a saturated copper/copper sulfate reference electrode contacting the electrolyte. Voltage drops other than those across the structure-to-electrolyte boundary must be considered for valid interpretation of this voltage measurement. **Note:** Consideration is understood to mean the application of sound engineering practice in determining the significance of voltage drops by methods such as:

- Measuring or calculating the voltage drop(s);

- Reviewing the historical performance of the cathodic protection system;
- Evaluating the physical and electrical characteristics of the pipe and its environment; and
- Determining whether or not there is physical evidence of corrosion.

3.1.2 A NEGATIVE POLARIZED POTENTIAL (the potential across the structure/electrolyte interface that is the sum of the corrosion potential and the cathodic polarization) of at least 850 mV relative to a saturated copper/copper sulfate reference electrode.

3.1.3 A MINIMUM OF -100 MV of cathodic polarization between the structure surface and a stable reference electrode contacting the electrolyte. The formation or decay of polarization can be measured to satisfy this criterion. This criterion is not valid when bimetallic corrosion, such as when connected to copper grounding, is present.

3.2 SPECIAL CONDITIONS

3.2.1 ON BARE OR INEFFECTIVELY COATED PIPELINES where long line corrosion activity is of primary concern, the measurement of a net protective current at predetermined current discharge points from the electrolyte to the pipe surface, as measured by an earth current technique, may be sufficient.

3.2.2 IN SOME SITUATIONS, such as the presence of sulfides, bacteria, elevated temperatures, acid environments, and dissimilar metals, the criteria in paragraph 3 may not be sufficient.

3.2.3 WHEN A PIPELINE IS ENCASED IN CONCRETE or buried in dry or aerated high resistivity soil, values less negative than the criteria listed in paragraph 3 may be sufficient.

CAUTION: Using polarized potentials less negative than -850 mV is not recommended for cathodic protection of pipelines when operating pressures and conditions are

conductive to stress corrosion cracking (see references on stress corrosion cracking in this chapter).

CAUTION: Use of excessive polarized potentials on coated pipelines should be avoided to minimize cathodic disbondment of the coating.

CAUTION: Polarized potentials that result in excessive generation of hydrogen should be avoided on all metals, particularly higher strength steel, certain grades of stainless steel, titanium, aluminum alloys, and pre-stressed concrete pipe.

Note: The earth current technique is often meaningless in multiple pipe rights-of-way, in high resistivity surface soil, for deeply buried pipe, in stray current areas, or where local corrosion cell action predominates.

3.3 ALUMINUM PIPING. The following criterion applies:

A minimum of 100 mV of cathodic polarization between the structure surface and a stable reference electrode contacting the electrolyte. The formation or decay of this polarization can be used in this criterion.

CAUTION: Excessive Voltages—Notwithstanding the minimum criterion, if aluminum is cathodically protected at voltages more negative than -1200 mV measured between the pipe surface and a saturated copper/copper sulfate reference electrode contacting the electrolyte, and compensation is made for the voltage drops other than those across the pipe-electrolyte boundary, it may suffer corrosion as the result of the buildup of alkali on the metal surface. A polarized potential more negative than -1200 mV should not be used unless previous test results indicate that no appreciable corrosion will occur in the particular environment.

CAUTION: Alkaline Conditions—Aluminum may suffer from corrosion under high pH conditions, and application of cathodic protection tends to increase the pH at the metal surface. Therefore, careful investigation or testing should be conducted before applying cathodic protection to stop pitting attack on aluminum in environments with a natural pH in excess of 8.0.

3.4 COPPER PIPING. The following criterion applies: A minimum of 100 mV of cathodic polarization between the structure surface and a stable reference electrode contacting the electrolyte. The formation or decay of this polarization can be used in this criterion.

3.5 DISSIMILAR METAL PIPING. A negative voltage between all pipe surfaces and a stable reference electrode contacting the electrolyte equal to that required for the protection of the most anodic metal should be maintained.

CAUTION: Amphoteric materials that could be damaged by high alkalinity created by cathodic protection should be electrically isolated and separately protected.

4. OTHER CONSIDERATIONS

4.1 DETERMINING VOLTAGE DROPS. Methods for determining voltage drop(s) shall be selected and applied using sound engineering practices. Once determined, the voltage drop(s) may be used for correcting future measurements at the same location providing conditions, such as pipe and cathodic protection system operating conditions, soil characteristics, and coating quality, remain similar.

Note: Placing the reference electrode next to the pipe surface may not be at the pipe-electrolyte interface. A reference electrode placed at a coated pipe surface may not significantly reduce soil voltage drop in the measurement if the nearest coating holiday is remote from the reference electrode location.

4.2 SOUND ENGINEERING PRACTICES. When it is impractical or considered unnecessary to disconnect all current sources to correct for voltage drop(s) in the pipe-electrolyte potential measurements, sound engineering practices should be used to ensure that adequate cathodic protection has been achieved.

4.3 IN-LINE INSPECTION OF PIPES. Where practicable, in-line inspection of pipelines may be helpful to determine the presence or absence of pitting corrosion damage. Absence of corrosion damage or the halting of its growth may indicate adequate corrosion control. The in-line inspection technique, however, may not be capable of detecting all types of corrosion damage, has limitations in its accuracy, and may report as anomalies items that are not corrosion. For example, longitudinal seam corrosion and general corrosion may not be readily detected by in-line inspection. Also, possible thickness variations, dents, gouges, and external ferrous objects may be detected as corrosion. The appropriate use of in-line inspection must be carefully considered.

4.4 STRAY CURRENTS AND STRAY ELECTRICAL GRADIENTS. Situations involving stray currents and stray electrical gradients may exist that require special analysis.

5. ALTERNATIVE REFERENCE ELECTRODES

5.1 ALTERNATIVE TO SATURATED COPPER / COPPER SULFATE. Other standard reference electrodes may be substituted for the saturated copper/copper sulfate reference electrode. Two commonly used reference electrodes are listed below along with their voltage equivalent (at 25 °C, [77 °F]) to -850 mV referred to a saturated copper/copper sulfate reference electrode:

- Saturated KCl calomel reference electrode: -780 mV
- Saturated silver/silver chloride reference electrode used in 25 ohm-cm seawater: -800 mV.

5.2 ALTERNATIVE METALLIC MATERIAL OR STRUCTURE. In addition to these standards reference electrodes, an alternative metallic material or structure may be used in place of the saturated copper/copper sulfate reference electrode if the stability of its electrode potential is ensured and if its voltage equivalent referred to a saturated copper/copper sulfate reference electrode is established.

6. TESTING

6.1 POTENTIAL MEASUREMENT. Cathodic protection systems must be tested to assess system function and troubleshoot inadequate performance. Potential measurement, based on the theory of measuring an unknown potential by relating it to a known reference electrode, is the principal test procedure used. A measurement is taken by connecting the high resistance voltmeter negative lead to the reference electrode (half cell), and connecting the positive lead to the metal being tested. The reference electrode must contact the electrolyte that is in contact with the metal being tested. In soil and freshwater, a copper/copper sulfate reference electrode should be used; in saltwater, a silver/silver chloride reference electrode must be used. To prevent erroneous readings, the voltmeter used must have a minimum of 10 million ohms input resistance under normal conditions; under rocky or very dry conditions, it should have up to 200 million ohms input resistance.

CAUTION: If the voltmeter has a polarity switch (such as the M.C. Miller Model B3 Series) and a D'Arsonval movement (needle) that deflects only in the positive direction, select (-). If there is no polarity switch, attach connections backwards (negative lead to structure and positive lead to the reference cell) to prevent damage to the meter; then interpret the positive deflection as a negative reading.

6.2 SOURCES OF ERROR. There are five sources of error when taking a potential measurement of a structure:

- The accuracy of the reference electrode
- An IR error present when current is flowing
- An anode gradient field present when current is flowing
- Contact resistance error when the reference electrode is not in good contact with the electrolyte

- Influence of foreign structures (mixed potentials)

6.2.1 ACCURACY OF THE REFERENCE ELECTRODE. To prevent erroneous potential measurements, the accuracy of the reference electrode (half-cell) must be reliable. A valid (tested) reference electrode must be used to take all potential measurements. Proper maintenance of the half-cell is essential. If the electrolyte in the half cell is contaminated, or the metallic electrode is contaminated or oxidized, the potential of the cell changes.

- Temperature also affects the potential of the reference cell. There is an increase of approximately 0.9 mV per degree Celsius (0.5 mV per degree Fahrenheit), so a measurement of -0.85 at 21 °C (70 °F) would read -0.835 at 4 °C (40 °F), and 0.865 at 38 °C (100 °F).
- To determine the accuracy of a reference electrode, multiple reference electrodes must be used. In practice, there should be one reference electrode maintained properly, which is not used in the field, to check other reference electrodes against before they are used in the field. This “reference” reference electrode must be properly initiated and stored.

6.2.1.1 INITIATION OF A REFERENCE ELECTRODE. The copper/copper sulfate reference electrode must be properly cleaned and initiated to ensure accuracy. Improper cleaning or initiation can cause significant changes in the potential of the reference (and subsequent errors in all measurements taken). The metal electrode must be cleaned properly and the electrolyte solution must be prepared properly to ensure accuracy.

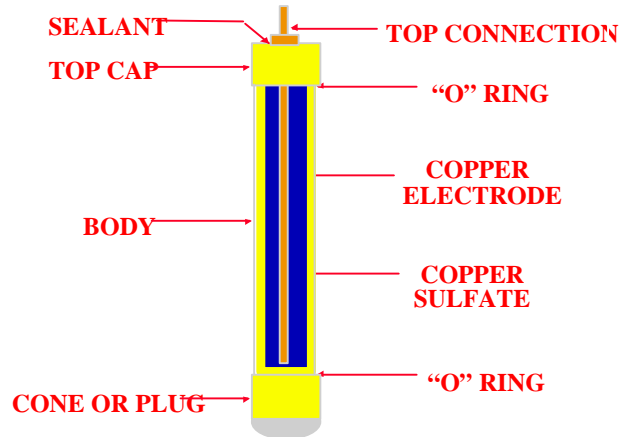

Figure 1

Copper/Copper Sulfate Reference Electrode (Half-Cell)

- **CLEANING.** Clean the metallic electrode thoroughly using nonmetallic materials: Do not use metallic sandpaper, grinders, emery cloth, wire brushes, knife blades, or any other metallic cleaning method. For example, aluminum oxide sandpaper will deposit particles of aluminum on the copper, or wire brushes will deposit particles of steel on the copper, thus changing the potential of the electrode. The proper way to clean the copper rod is with non-metallic sandpaper, such as flint paper, and a cloth. All of the copper oxide (green color) must be removed from the electrode, and it should be clean and shiny (no pitting). If the electrode is pitted, the accuracy is questionable and it should be replaced.
- **PREPARING THE ELECTROLYTE SOLUTION.** The electrolyte must be a fully saturated solution of copper sulfate. The half-cell body must be thoroughly cleaned, then rinsed out several times with distilled water before mixing the solution in the half-cell. There should be approximately one third the volume of copper sulfate crystals installed in the half-cell, then the remaining volume filled with distilled water. There should not be any copper sulfate crystals in the threaded area of the half-cell. This can be accomplished by slowly adding the distilled water to the threaded area while rotating the half-cell. The proper solution is a deep blue in color and after vigorous shaking; there must still be some copper sulfate crystals

that will not go into solution (fully saturated). If the half-cell has been previously used, additional steps are required. All parts should be inspected for cracks or other defects. O-rings should be replaced. The cone or plug must be replaced. To provide additional protection from subsequent leakage of the electrolyte from the half-cell, plumber's tape can be used on the threads of both the top cap and the end plug (new or used half cells). If the copper electrode is removed from the end cap or replacement of the end cap is required, the threads must be sealed with proper sealant when reinstalled, to prevent leakage of the electrolyte.

- **TESTING.** To determine the accuracy of a half-cell, use multiple reference electrodes. Using a "reference" reference electrode, measure the difference in potential to the half-cell under test. Use a meter on the millivolt scale, place the two cells cone-to-cone, and measure the potential difference. The potential difference should not be in excess of 5 mV. If no "reference" reference electrode is available, follow the procedures in 7.2.1.1 for initiation of a reference electrode on a new or used half-cell to get a reliable reference electrode, then test the potential difference (in mV) to other half cells. When a reference electrode is first initiated, allow sufficient time for the cone to become saturated (up to two hours). Placing the half-cell, cone end down, in a container of copper sulfate solution, can speed up the process.

6.2.2 IR DROP ERROR. There is an IR drop error caused by cathodic protection current flowing through the electrolyte (a resistor). This error is greater when the current is higher; when the resistivity is higher; when the distance from the reference electrode to the structure is higher; and on a well-coated pipeline, when the distance to the nearest holiday is greater. An instant-OFF or an IR free potential measurement will remove this error. This error is in the negative direction (for example, with the error, you may measure a -0.85 volt DC potential, and after correction for the error you may actually have -0.75 volts DC.)

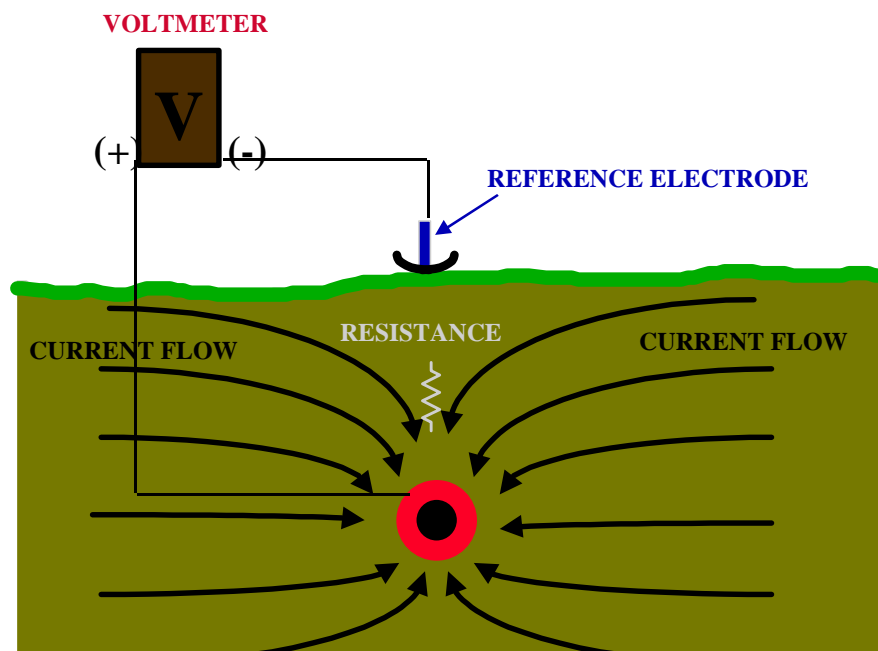

Figure 2
IR Drop Error

6.2.3 ANODE GRADIENT ERROR. The voltage gradient of the anode causes an error when the anode is connected in the circuit during testing (current is on). This error is greater when the voltage at the anode is higher and when the distance of the reference electrode to the anode is shorter. The cathodic protection circuit resistance, the number of anodes, and the electrolyte resistivity, affect the anode gradient field size. The anode gradient is larger when the circuit resistance is higher. The causes of high circuit resistance are high soil resistivity, low number of anodes, and anodes being spaced too close together. Placement of the half-cell is a major factor in determining the true potential of the structure. In an impressed current system, if the anodes are not truly in remote earth, there is a mixed potential reading of the structure being tested and the anode potential when taking a potential measurement with the anode in the circuit. An instant-OFF potential measurement will remove any possibility of this error. This error is in the negative direction (for example, with the error, you may measure -0.85 volts DC, and after correction for the error you may actually have -0.75 volts DC.)

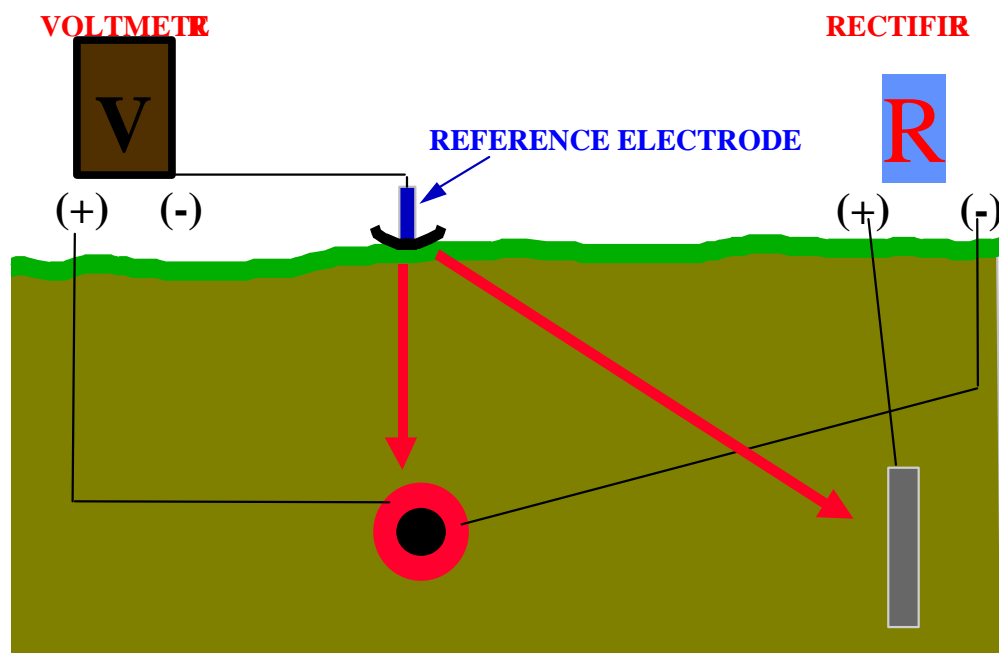

Figure 3
Anode Gradient Error

6.2.4 CONTACT RESISTANCE ERROR. Poor contact of the reference electrode to the electrolyte results in error. The contact resistance of the half-cell to earth is problematic under rocky or dry conditions. Apply water on dry ground and/or use a very high resistance voltmeter. Cathodic protection voltmeters have selectable input resistance from 1 million to 200 million ohms. Normally, 10 million ohms is the selected scale; while taking a potential measurement, switch the input resistance to the next higher selection. If the reading does not change, the contact resistance is insignificant. If the reading does change, select the next higher input resistance, and continue until the reading does not change. If the highest selection still changes the reading, add water and retest. This error is in the positive direction (for example, with the error you may measure -0.85 volts DC, and after correction for the error you may actually have -0.95 volts DC.) The input resistance of the meter used must be much greater than the contact resistance to ensure accuracy of the measurement.

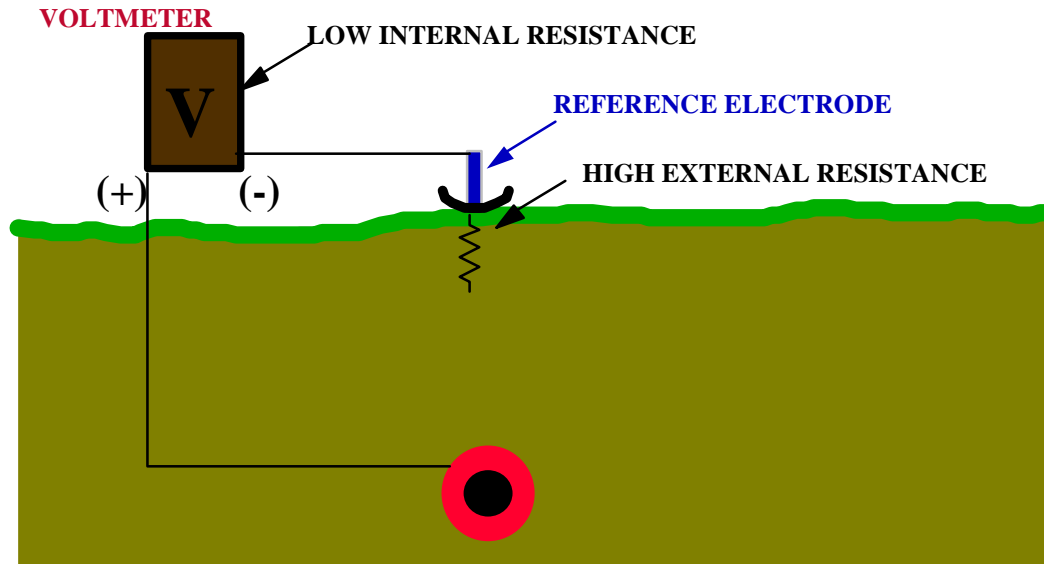

Figure 4
Contact Resistance Error

6.2.5 MIXED POTENTIAL ERROR. Error results when a potential measurement being taken on the structure is mixed with the potential of other structures also connected to the circuit being tested. This error can be significant when the coating on the structure being tested is very good and there are other structures in the area not isolated from the cathodic protection system. This error is present when the system being tested is not isolated, and is greater when the condition of the coating is better, the distance to the nearest holiday is greater, the distance of the half-cell to the other structure is shorter, when the coating of the other structure is worse (or bare), and when the native potential of the other metal is less negative (more cathodic, such as copper). This error is usually in the positive direction (for example, you may measure -0.85 volts DC, and after correction for the error you may actually have -0.95 volts DC). This error can be in the negative direction if caused by contact with a more negative (more anodic) metal, such as aluminum, zinc (galvanized steel), magnesium, or some stainless steels in the passive state.

Another source of a more positive mixed potential could be a small anodic area on the structure being tested, with larger cathodic areas on the same structure influencing the

potential measurement. This error is greater when the size of the more positive area is smaller, the distance of the reference electrode to the structure is greater, and when the size of the more negative area is greater.

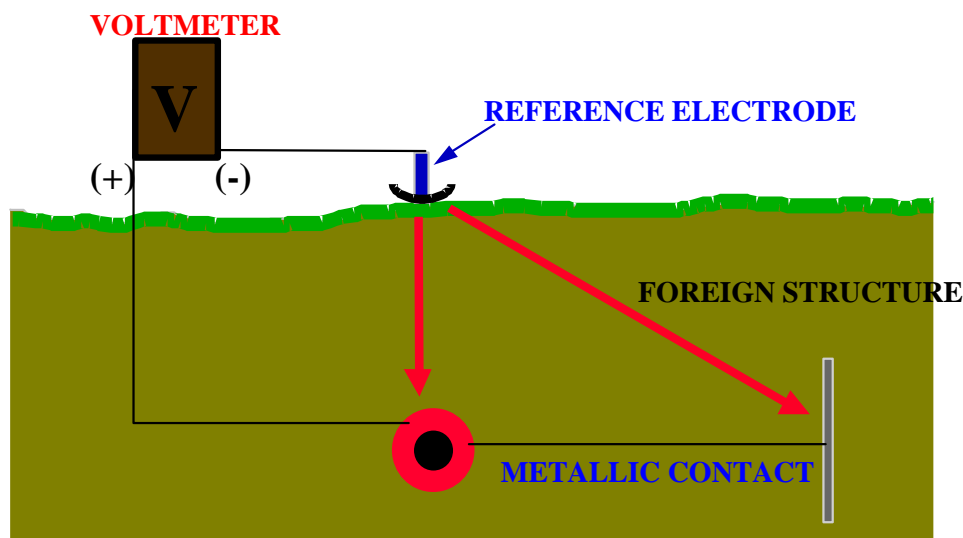

Figure 5
Mixed Potential Error

6.3 PRACTICAL MEASUREMENT OF CATHODIC PROTECTION POTENTIALS

6.3.1 TEST CRITERIA SELECTION. The method used for potential testing varies widely for different types of structures and for the different criteria used for evaluation of the potentials taken. Sometimes different criteria may be used for different areas on the same structure. The criteria selected depend mostly on the type of the structure, isolation/non-isolation of the structure, structure coating type and efficiency, the type of cathodic protection system, the soil resistivity, the amount of current supplied by the CP system, and the instrumentation available for testing.

6.3.1.1 SACRIFICIAL CATHODIC PROTECTION SYSTEM. Generally, the criterion for sacrificial CP systems is -0.85 ON. IR error must be compensated for, usually by placing the reference electrode as near to the structure as possible (directly over the pipeline or

tank) and as remote as possible from any sacrificial anode. This, combined with knowledge of the structure coating, soil resistivity, the size and spacing of the anodes and the anode current, is usually enough to determine the adequacy of the CP applied to the structure. If in doubt, or when potential readings are questionable, excavate to allow placement of a temporary reference electrode or permanent reference electrode as close as practical to the structure to further minimize any possible IR error. Sacrificial systems are normally used in low soil resistivities (low IR error), on well coated structures with a low current requirement (low IR error), and because of the very small driving voltage (under one volt), have a very small amount of current flow (low IR error). If the dielectric strength of the structure coating is not good, the soil resistivity is relatively high, or the location or spacing of the anodes makes it impossible to measure the structure potential remote from the anodes, other criteria should be used or excavations made to properly place the reference electrode to obtain a valid potential measurement. For very small and well-coated structures (such as valves, elbows, and tie downs), use the 100 mV polarization criterion. For all sacrificial systems, if the sacrificial system is designed to allow interrupting the current from all anodes simultaneously, the -100 mV polarization criterion could be used. The -0.85 instant OFF criterion is usually not attainable in most soil conditions with sacrificial anodes, unless the native potential of the structure is very high and/or the soil resistivity is very low. The -0.85V instant-OFF criterion should not be used for sacrificial CP systems except in rare cases; use the 100 mV shift criterion or the -0.85 ON criterion (considering IR).

6.3.1.2 IMPRESSED CURRENT CATHODIC PROTECTION SYSTEM. The first consideration for determining the criteria to use with impressed current CP systems is the type of anode bed used.

- For distributed anode impressed current systems, the -0.85 instant-OFF or the 100 mV polarization criterion should be used; the -0.85 ON criterion should not be used. For structures with a high dielectric strength coating, the -0.85 instant-OFF criterion may be the easiest to use, although the 100 mV polarization criterion can be used. For structures which are bare, poorly coated, or have a deteriorated coating, the 100 mV polarization criterion should be used.

- For remote anode impressed current systems, all criteria, or a mixture of criteria may be used. If the anodes are truly remote from the test point, the electrolyte resistivity is low, the dielectric strength of the coating is high, and the circuit resistance of the CP system is low, the -0.85 ON criterion (considering IR error) is sufficient. Accounting for voltage drops other than those across the structure-to-electrolyte boundary is usually accomplished by placing the reference electrode as near to the structure as possible (directly over the pipeline or tank). This, combined with knowledge of the dielectric strength or the structure coating, size of the structure, the electrolyte resistivity, the distance and voltage at the anodes, the rectifier output voltage, and the rectifier output current, is usually enough to determine the adequacy of the CP applied to the structure. If in doubt, or when potential readings are questionable, test the location using another criterion, or excavate to locate a temporary reference electrode (or install a permanent reference electrode) as close as practical to the structure to further minimize any possible IR error. For structures with a high dielectric strength coating, regardless of the electrolyte resistivity, distance from the anodes, or the CP system circuit resistance, the -0.85 instant-OFF criterion may be the easiest to use, although the 100 mV polarization criterion can be used. For structures which are bare, poorly coated, or have a deteriorated coating, the 100 mV polarization criterion should be used.

6.3.2 TEST METHODS FOR THE -0.85 ON CRITERION. A single electrode potential survey is conducted using any high impedance or high input resistant voltmeter (10 megohms or higher). The voltmeter positive is connected to the structure under test and the voltmeter negative is connected to the reference electrode to display the proper polarity (for analog meters which only read in the positive direction, the leads must be connected backwards to get an upscale deflection, and the negative value must be inserted when recording the measurement). The -0.85 volts DC is measured to a copper/copper sulfate reference electrode (half-cell). Other types of reference electrodes must be corrected to the copper/copper sulfate reference to use the -0.85 volt criterion.

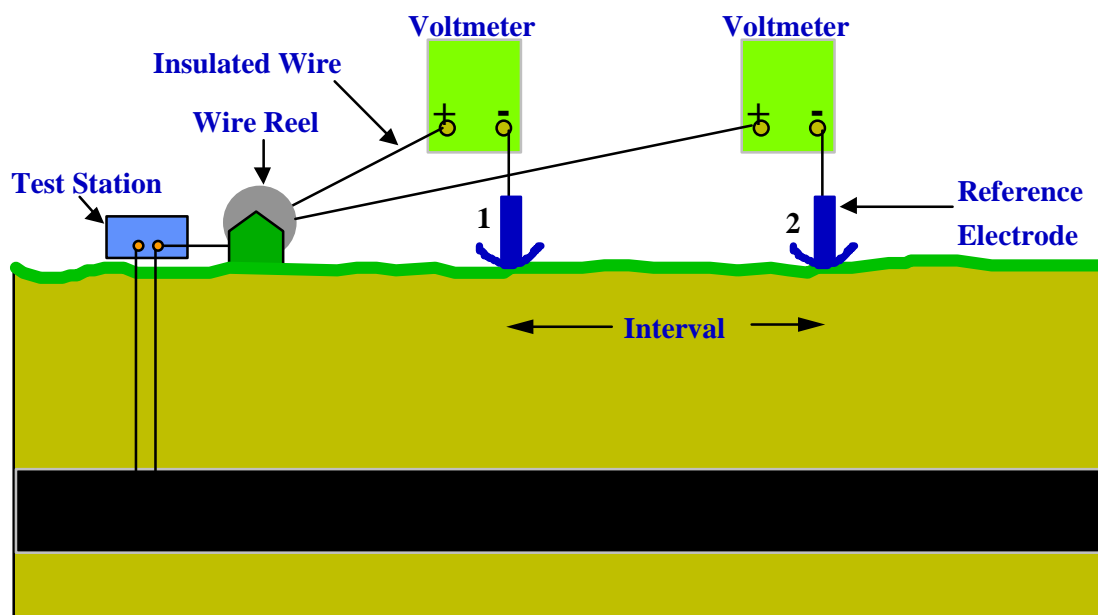

Figure 6
Single Electrode Potential Survey

Since these potential readings are taken with the cathodic protection current on, there are errors in the measurement which must be considered to obtain a valid conclusion that adequate cathodic protection exists on the protected structure. Chapter 6 of this handbook and NACE International Recommended Practice (RP) 0169-92, Section 6.2.2 for steel and cast iron piping, states that voltage drops other than those across the structure-to-electrolyte boundary must be considered for valid interpretation of this voltage measurement. Consideration is understood to mean the application of sound engineering practice in determining the significance of voltage drops by methods such as:

- Measuring or calculating the voltage drop(s).
- Reviewing the historical performance of the cathodic protection system.
- Evaluating the physical/electrical characteristics of the pipe and its environment.
- Determining whether or not there is physical evidence of corrosion.

All the errors listed in above must be evaluated. Interruption of the CP current does not fall under this criterion, since that would pertain to the -0.85 instant OFF or the 100 mV polarization criterion. Measuring or calculating the voltage drop(s) includes measuring all the factors that affect the magnitude of the voltage errors present in the ON reading. These measurements include the anode output, rectifier current output, structure coating efficiency, location of the reference cell in relation to the anodes and the structure, electrolyte resistivity, comparison to previous potentials (native, ON, and/or instant OFF) and other factors which may contribute to the corrosion rate (presence of stray current, interference, bi-metallic connections, pH, temperature, homogeneity of the soil, amount of oxygen, presence of bacteria, and presence of other ions or contaminants which may affect the corrosion rate). Implementation of this criterion is only possible when these factors can be quantitatively verified by measurement these factors, or historical evidence that these factors have been considered. Factors that decrease magnitude of the voltage drop errors or otherwise slow or stop the corrosion rate include:

- High dielectric strength coating. A 99 percent to 99.7 percent effective coating drastically lowers the amount of current to obtain adequate cathodic protection; consequently IR error is also drastically lowered.
- Low electrolyte resistivity. As resistivity is lowered, the IR drop error is lowered. Also for impressed current systems, the circuit resistance is lower, resulting in a lower voltage at the anode (to obtain the same current), lowering any anode gradient errors.
- High pH (7 to 13). A high pH in the electrolyte near the protected structure indicates cathodic protection is present, but amphoteric materials could be damaged by the high alkalinity created by the cathodic protection.
- Low temperatures, which decrease the corrosion rate.
- Current density.

- Lack of bimetallic connections. If present they would raise the corrosion rate.
- Lack of interference corrosion. Interference raises the potential in the pickup area (lowers corrosion) and lowers the potential in the discharge area (increases the corrosion rate).

6.3.3 TEST METHODS FOR THE -0.85 INSTANT-OFF CRITERION. For this criterion, measurements of potential must be taken when there is no cathodic protection current flowing. The measurement of the instant-OFF or the potential when the cathodic protection is not flowing is required as the means of removing errors from the measurement. For various methods used to measure the instant-OFF potential, see paragraph 3.5. If the potential measurement meets or exceeds -0.85 volts DC (in comparison to a copper/copper sulfate reference electrode) using these methods, this criterion has been met. Other reference electrodes must be corrected to the factor for a copper/copper sulfate reference to be valid under this criterion.

6.3.4 TEST METHODS FOR THE 100 MV POLARIZATION CRITERION. The test method for this criterion is exactly like the method for the negative 0.85 instant-OFF criterion, with the additional requirement of either comparing the measurements to a native survey (potentials taken before the cathodic protection current was applied), or allowing for the measurement of the polarization decay. It is recommended that the native potentials be used to compare the instant-OFF readings for the 100 mV polarization criterion. After cathodic protection has been applied, the structure is polarized, and even after current interruption, considerable time may be required before the potential returns to the native potential value. Measuring polarization decay guarantees the proper shift, but may require considerably more current to polarize the structure to a level where the 100 mV depolarization would occur in a relatively short time.

6.3.5 INSTANT-OFF TEST METHODS. The test method used for an instant-OFF potential measurement is determined by the type of equipment used and the type of current interrupter used. The test method must include interruption of the protective current or measurement of the potential when there is no current flowing, to guarantee

the removal of all IR drop and anode gradient errors. There are four different equipment technologies that are used and several ways to accomplish the current interruption (sometimes depending on the type of equipment being used). Types of equipment include:

- A normal high input impedance digital voltmeter may be used in combination with conventional current interrupters, manually synchronizable, or advanced synchronizable interrupters (not pulse generators, unless used as a conventional interrupter).
- A data logger which records potential measurements very quickly (from four to several thousand readings per second) may be used in combination with conventional current interrupters, manually synchronizable, or advanced synchronizable interrupters (not pulse generators, unless used as a conventional interrupter), then analyzing the data (sometimes using computer software) to determine the instant-OFF potential reading.
- A waveform analyzer may be used together with a pulse generator to calculate the OFF potential.
- A high speed data logger and oscilloscope (or similar very high speed recording device) may be used to analyze the unfiltered signal on the structure to obtain the potential of the structure when the DC output waveform is at zero current output. This technology may only be applicable with potential measurements that are affected by only one single-phase rectifier, with all filters and chokes disconnected from the rectifier output and may not remove all anode gradient errors.

6.3.6 TYPES OF INTERRUPTERS. The type of interrupter used depends on the number of rectifiers or DC current sources and the type of equipment used to perform the instant-OFF measurements. Manual interruption of a cathodic protection rectifier using an AC power switch, rectifier circuit breaker, or other means is generally not recommended. The time to manually open and close contacts, coupled with interruption of the AC side of the

circuit does not provide accurate or repeatable measurements under many conditions within the first second of interruption, resulting in significant inaccuracies in the measurement obtained. Manually operated relay contacts are sometimes used, and may produce repeatable results if they have a quick open and closed mechanism and are installed in the DC output of a rectifier. Using radios to signal operators to open and close contacts, breakers or switches could also produce erroneous readings due to RF signals from the radio which may induce voltages in the meter being used to measure or record the measurement, especially with analog meters or unfiltered digital meters.

6.3.6.1 CONVENTIONAL INTERRUPTER. The conventional current interrupter provides for timed interruption of a rectifier DC output current. This is normally accomplished by opening the circuit either between the anodes and the rectifier, or the structure and the rectifier. Units normally provide independent control of open and closed time intervals. Variations in the accuracy of the interruption timing, current ratings of the relay contacts, and the selection increments of the on and off cycles vary between units. These units are normally installed temporarily in the rectifier output circuit during testing, but sometimes are optionally installed in the rectifier cabinet. Quartz crystal controlled units are usually accurate to within one second a day. These units are typically powered by batteries installed internally, or with an external DC power source through a panel plug.

6.3.6.2 MANUALLY SYNCHRONIZABLE INTERRUPTER. This unit is similar to a high quality conventional interrupter (may be accurate to within one tenth of a second in 24 hours) with the additional feature of synchronizing the interruption cycle with other like units. This is normally accomplished by using a supplied cable to temporarily connect two units together, to start second, third, fourth, etc., units for synchronization of the interruption cycles of all units. These units make it possible to interrupt several rectifiers simultaneously to use various instruments to measure an instant-OFF potential reading. They are usually portable, but could possibly be installed equipment, with a portable unit used to synchronize the rectifier-installed units.

6.3.6.3 ADVANCED SYNCHRONIZABLE INTERRUPTER. These units are similar to a manually synchronizable interrupter with the means of synchronization controlled by

some communication technology (versus manually by cable connection) such as radio, computer connection, modem, or satellite transmissions. They are usually permanently installed, but portable units are also available.

6.3.6.4 PULSE GENERATOR. The pulse generator can normally be used as a conventional current interrupter or as a standard pulse generator. They may be permanently or temporarily installed in the rectifier cabinet. They do not require synchronization when used together with the proper waveform analyzing equipment. If used for a conventional current interrupter, they are not synchronizable, but usually provide for user-selectable interrupt cycles. The standard pulse generator is connected in series in the DC output (either positive or negative) of the rectifier(s) and produces a precisely timed, zero-current pulse that does not drift. AC supply voltage is used to power the pulse generator. Selectable input AC power units must be set for the correct AC supply voltage being used. Ensure the pulse generator is set to the proper voltage before applying AC power, or the pulse generator will be damaged.

6.3.7 SPECIFIC METHODS FOR VARIOUS INSTANT-OFF POTENTIAL MEASUREMENT TECHNIQUES

6.3.7.1 USING NORMAL DIGITAL VOLTMETER WITH CURRENT INTERRUPTER(S).

The digital voltmeter may be used together with a current interrupter to measure an instant-OFF potential. For locations that are affected by more than one rectifier or DC current source, synchronized interruption must be accomplished. For locations that are affected by more than three to six rectifiers or DC current sources (according to their contribution or availability of synchronizable interrupters), subsequent systems can be turned off to preclude their contribution to the instant-OFF reading.

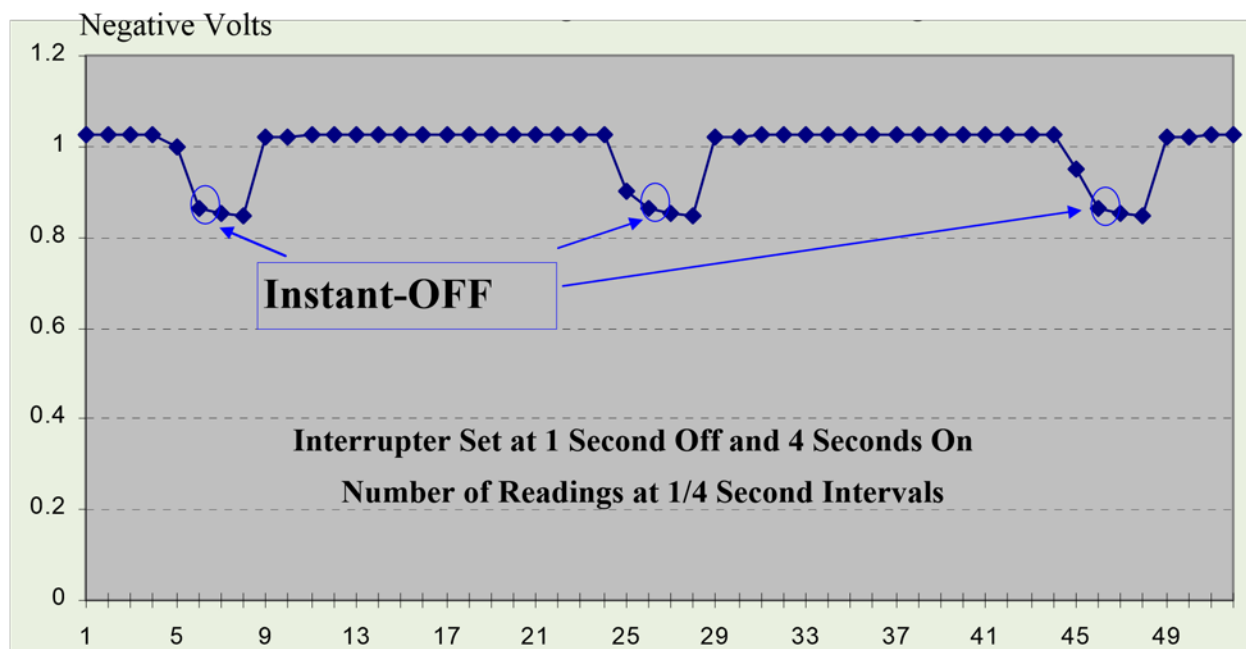

Figure 7

Typical Displayed Readings Using Digital Voltmeter

- Limitations of a meter using a needle to display the measurement (D'Arsonval movement) preclude their use for this application. The needle swing is a relatively slow movement which may be slower than the initial depolarization which occurs after interruption; by the time the needle swing catches up with the actual measured potential, significant depolarization may have already occurred. If used, this technique would yield a measurement value that is less than the actual instant-OFF, which can be measured using other methods.
- Typical digital voltmeters take hundreds or thousands of readings a second, but normally update the display only after a change in the reading or about every $\frac{1}{4}$ of a second under constantly changing conditions. The actual instant-OFF measurement must be determined by viewing the digital display and manually recording the measurement. Since the display is updated only after a change, and is only updated about every $\frac{1}{4}$ second under changing conditions, the display must be interpreted. Normally, the display is constant (not changing) while the current

is on. When the current is interrupted, the meter must recognize the change, average the measurement and update the display. This first blink contains an average of all the ON, all the OFF, and any spiking (either positive or negative) which has occurred since the last display update or about $\frac{1}{4}$ of a second. This first blink is not the instant-OFF: It contains part of the ON and should be disregarded. The second blink is the instant-OFF measurement, which should be recorded. Since this number is only displayed for about $\frac{1}{4}$ of a second, watching the display through several interruption cycles may be required to assure the correct value is recorded. The value recorded using this technique will have from about $\frac{1}{8}$ of a second to just under $\frac{1}{2}$ of a second of depolarization.

- Some digital meters have a memory function that will remember the minimum and maximum (ON and instant-OFF) readings and the meter can toggle between the two readings. Using this type of digital meter with the interrupter(s) on a short off cycle (usually 1 second), the meter can be reset, then the ON and instant-OFF displayed and recorded. The value recorded using this technique will have from about $\frac{1}{2}$ to just less than 1 second of depolarization (with a 1 second OFF cycle). Some interrupters are available which have the capability of a $\frac{1}{2}$ second OFF cycle, which could be used to obtain approximately the same accuracy as the previous method ($\frac{1}{8}$ of a second to just under $\frac{1}{2}$ of a second of depolarization).
- There are occasions where a significant depolarization may occur in the time required for these methods to obtain an instant-OFF reading. The speed of depolarization depends on the type of coating, the condition of the coating, the dielectric strength of the coating, the current density, and the type of electrolyte.

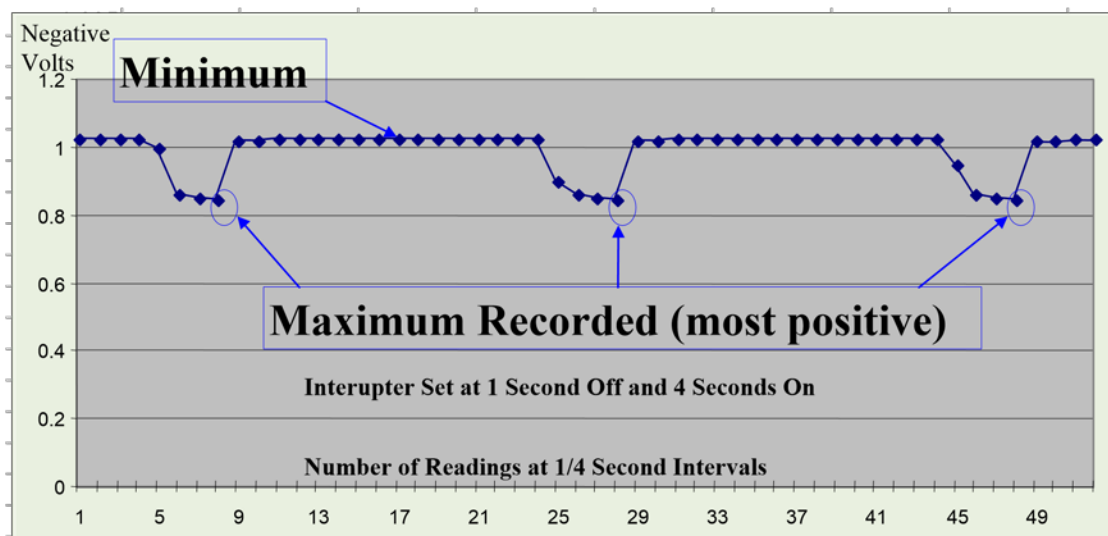

Figure 8

Readings Recorded by Digital Voltmeter with Minimum/Maximum Function (Reference Cell to Meter Negative, Structure to Meter Positive)

6.3.7.2 USING A DATA LOGGER WITH CURRENT INTERRUPTERS. As with digital meters, current interruption is required. The data logger records from four to several thousand readings per second. The measurements taken are not an average over time as with the digital meters. The location being tested is measured through at least one OFF cycle and the instant-OFF reading is extracted manually from the data, or extracted via a computer program that is designed for that purpose. Any positive or negative spiking that may occur when the current is interrupted or when it goes back on should be disregarded and is not considered a valid instant-OFF reading. Fast data loggers record more data resulting in a higher accuracy, but often require more time to extrapolate the correct reading. Very fast data loggers may require software analysis of the data to get the instant-OFF readings in a timely manner. Manually verify a representative sampling of the data to ensure the software is effectively extrapolating the correct reading. The value recorded using this technique will have from about zero (0.0003 seconds at 3000 per second) to under $\frac{1}{4}$ of a second (at four per second) of depolarization, according to the sampling speed of the data logger. It is possible at four readings per second to record a positive or negative spike as one of the readings (depending on synchronization timing

and the sampling timing of the data logger). In that case, the next reading would have a full $\frac{1}{4}$ second of depolarization.

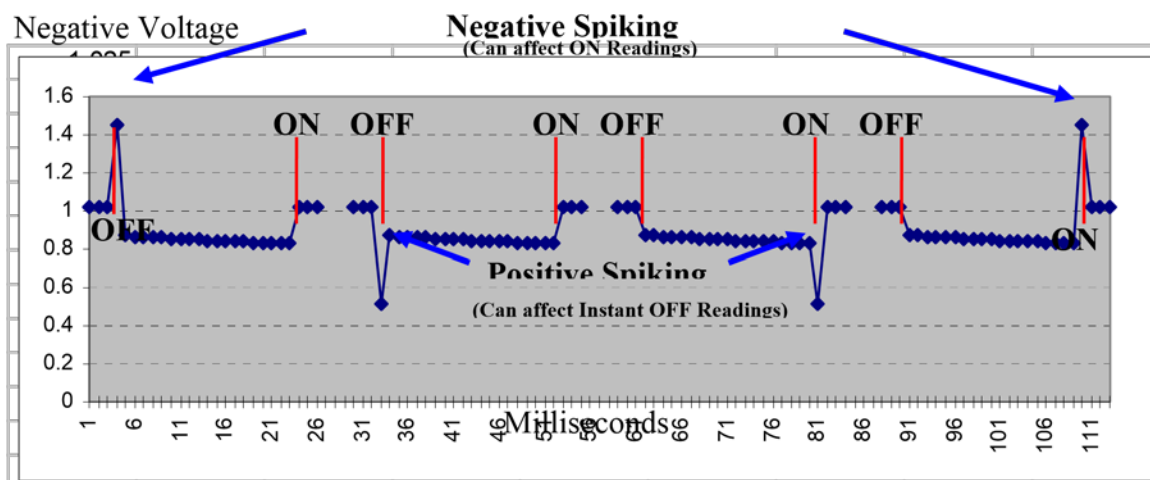

Figure 9

Examples of Voltage Spiking on Instant-OFF Readings

6.3.7.3 USING A WAVEFORM ANALYZER WITH A PULSE GENERATOR. The waveform analyzer is a microprocessor-based hand-held voltmeter that uses a complex computer algorithm to measure the ON and instant-OFF potentials. To accurately calculate the OFF potential, a pulse generator must be installed in all rectifiers or DC current sources that affect the location where the measurement is being made. The pulse generator interrupts the output of the rectifier on a precise timing cycle. This interruption generates the precisely timed zero current pulse which is required by the waveform analyzer to accurately calculate the OFF potential. Pulse generators do not require any synchronization. The waveform analyzer captures a digital picture of the potential waveform by recording thousands of voltage readings on the waveform. Digital signal processing techniques are then used to filter out any induced AC or 60-cycle noise in the waveform and the ON potential reading is calculated. The error from the six pulse generators having the greatest influence on the reading is determined by analyzing the zero current pulses from all pulse generators affecting the waveform, and the OFF potential reading is calculated by subtracting the error from the ON reading. If the location

under test is suspected to have more than six rectifiers or DC current sources significantly affecting the potential, separate testing should be conducted to verify or eliminate that possibility. If there are more than six sources of current affecting the potential at a particular location, determine the six sources with the greatest influence and turn the rest off so that their effect is not considered as part of the off potential. The value recorded using this technique will have very little or no depolarization in the measurement.

6.3.7.4 USING A HIGH SPEED DATA LOGGER AND A FILTERED OSCILLOSCOPE.

The oscilloscope is used to analyze the rectifier output waveform, and the high-speed data logger is used to obtain a digital picture of the potential signal on the structure. This technology simultaneously measures the rectifier output waveform and the potential waveform, and by comparison extrapolates the potential measurement when the rectifier waveform is at zero current. This technology may only be applicable with potential measurements that are affected by only one single-phase rectifier, with all filters and chokes disconnected from the rectifier output. Since the data logger is connected to the structure with a closed circuit to the anodes through the rectifier, the potential of the anodes could still affect the potential measurement if readings are taken in the vicinity of the anodes. On a well-coated structure, the distance required to remove the possibility of a mixed potential (anode and structure) would be greater. This technology will not work with a three-phase rectifier system or where more than one rectifier is protecting the structure.

6.4 STRUCTURE-TO-SOIL POTENTIAL LIMITS

6.4.1 EXCESSIVE CATHODIC PROTECTION CURRENT. Excessive cathodic protection current produces hydrogen gas evolution at the surface of the cathode. If the gas is produced faster than it can permeate the coating, bubbling of the coating will occur. The amount of coating damage is dependent on the amount of gas generated and the type of coating. This condition is normally called “blowing off” the coating. When this occurs, more of the structure is exposed to the electrolyte and the circuit resistance between the anodes and the cathode becomes lower. This causes more current to be impressed to this location, and usually, more gas evolution. This phenomenon results in

more coating damage and is very detrimental to current distribution, since more current goes to that location, and less current goes to other, more remote, locations.

6.4.2 WATER STORAGE TANKS. The coatings used in water storage tanks are the most prone to this damage. This type of coating disbonds very easily as compared to coatings used on underground structures. It is not uncommon for elevated or ground level water storage tanks to have the coatings bubbled or blown off from excessive cathodic protection. It is essential on these tanks to maintain the level of current at a safe level. The accuracy of permanent reference electrodes used with automatic systems should be of concern when performing the CP System Check. The ON potentials of coated water storage tanks have many errors in the measurement (paragraph 2.3). ON potential measurements over -1.10 volts DC to a copper/copper sulfate reference electrode should be suspected of coating damage and instant-OFF potentials taken. Coating damage should be expected when the potential measurement is over -1.50 volts DC to a copper/copper sulfate reference electrode and instant-OFF potentials must be taken. The instant-OFF potentials should not exceed -1.00 volt DC and must never exceed -1.10 volts DC to a copper/copper sulfate reference electrode.

6.4.3 UNDERGROUND STRUCTURES. Coatings for underground structures are generally resistant to this damage. The ON potentials of underground structures also have many errors in the measurement (paragraph 2.3). ON potential measurements to a copper/copper sulfate reference electrode should be suspected of coating damage if over the potentials listed in Table 23 “SUSPECTED” column, and instant-OFF potentials should be taken. Coating damage should be expected when the potential measurement is over the potential listed in Table 23, “EXPECTED” column, and instant OFF potentials must be taken. This figure assumes an IR drop error and is given for information only. The only true way to measure this possible damage is with an error-free measurement (paragraph 3). Instant-OFF measurements should be used whenever possible. Instant-OFF measurements that are over approximately -1.22 volts DC are not theoretically possible. If instant-OFF readings are significantly over -1.22 volts DC, other DC current sources are present. Synchronous interruption of all current sources must be accomplished.

- For fusion-bonded coatings, the instant-OFF potentials should not exceed 1.07 volts DC and must never exceed -1.12 volts DC to a copper/copper sulfate reference electrode.
- For coal tar coatings, the instant-OFF potentials should not exceed -1.12 volts DC and must never exceed -1.20 volts DC to a copper/copper sulfate reference electrode.
- For plastic tape coatings, the instant-OFF potentials should not exceed -1.02 volts DC and must never exceed -1.07 volts DC to a copper/copper sulfate reference electrode.
- For other coatings, refer to specifications for cathodic disbondment properties compared to above coatings.

6.4.4 UNCOATED STRUCTURES. For uncoated structures, there are no theoretical potential limits. Instant-OFF readings over -1.00 generally waste power and anode material. Instant-OFF measurements that are over approximately -1.22 volts DC are not theoretically possible. If instant-OFF readings are significantly over -1.22 volts DC, other DC current sources are present. Synchronous interruption of all current sources must be accomplished.

Average Soil Resistivity	Coating Damage	
	Suspected	Expected
2,000	-1.20	-1.80
3,000	-1.30	-2.20
5,000	-1.40	-2.50
10,000	-1.60	-2.70
15,000	-1.75	-2.75
20,000	-1.90	-3.00
30,000	-2.05	-3.30
40,000	-2.20	-3.60
50,000	-2.35	-3.90
100,000	-2.60	-4.40

Table 1
Potential Limits for Underground Coated Structures

6.5 CELL-TO-CELL POTENTIAL TESTING PROCEDURES

6.5.1 PERFORMING TEST. Cell-to-cell potential testing is performed to determine the direction of current flow in the earth. This is especially useful on unprotected pipelines to locate the anodic areas on the pipeline. These procedures are not used on protected structures. On unprotected pipelines when cathodic protection of the complete line is not feasible or economical, hot spot protection is sometimes used. This test procedure is used to identify the anodic areas of the pipeline for application of cathodic protection to those locations. The polarity of the voltage difference between the two reference cells indicates the direction of current flow.

6.5.2 ACCURACY. The accuracy of the reference electrodes (half cells) used to take cell-to-cell measurements must be determined. Perfect matching of the two reference cells is not essential, but the error must be accounted for in all measurements taken. The accuracy of the two half-cells is determined by measuring the difference in potential between the two half cells being used for the test. Use a suitable voltmeter on the millivolt scale and place the two cells cone-to-cone, and measure the potential difference. The potential difference should not be in excess of 5 mV. If no “reference” reference electrode is available, follow paragraph 2.1.1 on a new or used half-cell to get a reliable reference electrode, then test the potential difference (in mV) to other half cells. When a reference electrode is first initiated, time must be allowed for the cone to become saturated. This process takes up to two hours, but can be speeded up by placing the half-cell, cone end down, in a container of copper sulfate solution. See paragraph 2.1 for the procedures for checking the reference electrodes.

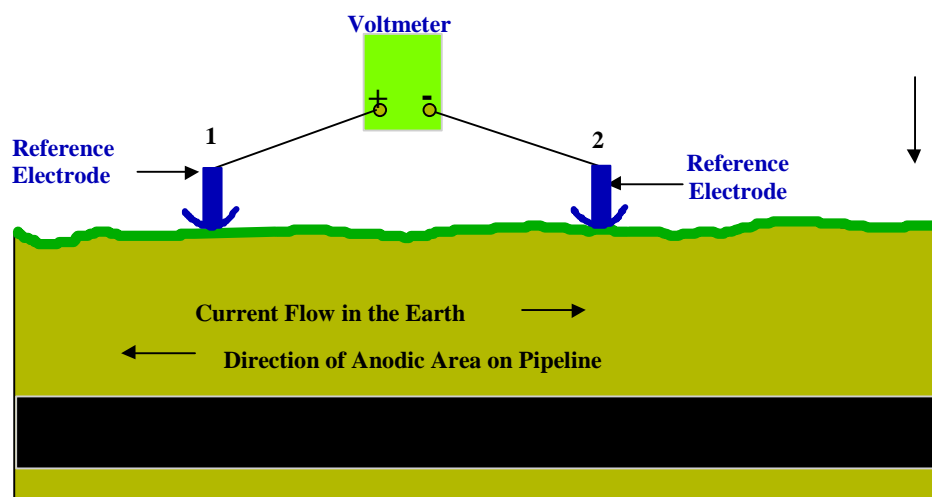

Figure 10
Positive Reading for Cell-To-Cell Survey

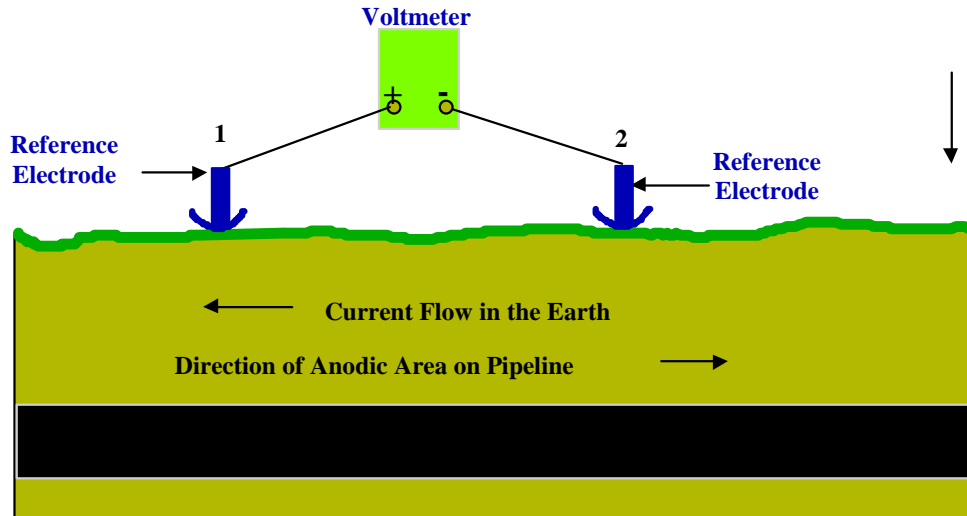

Figure 11
Negative Reading for Cell-To-Cell Survey

6.6 RECTIFIER EFFICIENCY TESTING PROCEDURES

6.6.1 DETERMINING EFFICIENCY. The efficiency of a rectifier is determined by measuring the output voltage, output current, calculating the input in watts, and using the following formula:

$$\text{Rectifier Efficiency} = \frac{\text{Output Current} \times \text{Output Voltage}}{\text{Input Watts}}$$

**Input Watts = Revolutions per hour of the kWh meter disc X factor shown on the face of the kWh meter.

6.6.2 ALTERNATE PROCEDURE. An alternate procedure to obtain the input watts is simply measuring the AC input voltage and the AC input current (by using an accurate clamp-on ammeter or by disconnecting and measuring AC amps with appropriate procedures similar to the above, measuring AC voltage). This method neglects the power factor and will not be truly accurate, but will give a reasonable approximation. If this method is used, subsequent efficiency testing should be done in the same manner to obtain comparable results.

$$\text{Rectifier Efficiency} = \frac{\text{Output Current} \times \text{Output Voltage}}{\text{Input Current} \times \text{Input Voltage}}$$

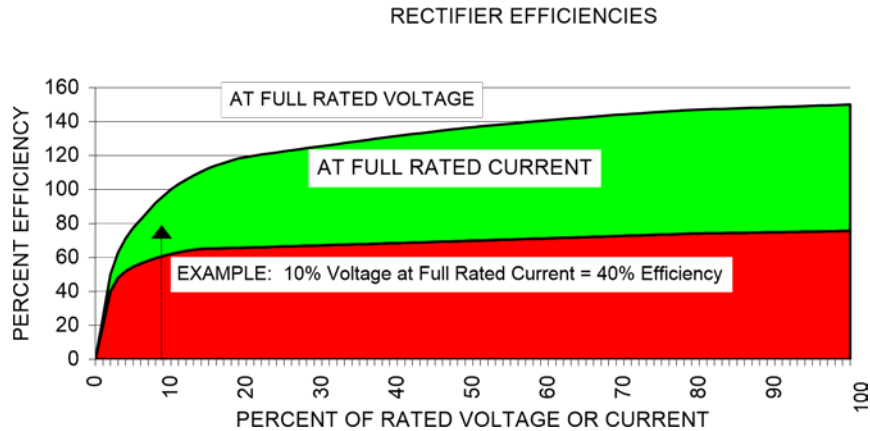

Figure 12. Rectifier Efficiency

6.6.3 EXPECTED EFFICIENCY. The expected efficiency of a rectifier depends on the type of AC power (single or three-phase), Type of rectifying elements (selenium or silicon), type of rectifier (bridge or center tap), and the percent of load of the unit. The selenium bridge rectifier is the most common unit. The selenium inherently is less efficient due to the voltage drop of the rectifier elements (and resultant heat). Selenium ages with time and becomes less efficient as time passes.

6.7 DIELECTRIC TESTING PROCEDURES. Shorted dielectrics adversely affect the operation of cathodic protection systems. If a cathodic protection system is designed to protect an isolated structure, shorted dielectrics will normally result in loss of adequate protection to that structure. Shorts may also result in poor current distribution or shielding which will result in the loss of adequate protection to areas of the structure. Testing an installed dielectric presents several problems. Since typical installations normally include many dielectrics, all of which are in a parallel circuit, failure of one dielectric can effectively short the entire system. There are indications of the shorted condition of one dielectric at many, or all, other dielectrics installed. Usually, the further the distance is between the dielectric being tested and the dielectric that is shorted, the easier it is to test that

dielectric. Most methods of testing a dielectric give a reliable indication of only one condition of the dielectric (either shorted or not shorted condition) and further testing may be required for the other condition. Only one method gives a totally reliable indication of an installed dielectric. The radio frequency tester (insulated flange tester), because of its wavelength and the strength of the signal, gives a true indication of the condition of that specific dielectric. This method will not read through other parallel paths, even when these paths are in the immediate vicinity. In fact, this method can pinpoint the fault to a particular flange bolt or the flange gasket.

Therefore, this method should be used for testing when any other method is not conclusive. The preferred method to determine if a dielectric may be shorted is by potential testing. This method will normally provide an immediate indication if the dielectric is not shorted, and at the same time provide valuable potential data. If this method indicates the dielectric may be shorted, other methods of verification are required. The radio frequency tester (insulated flange tester) should be used when a shorted condition is indicated by potential measurements. Alternate methods of verification may be used to test installed dielectrics. These methods include the pipe locator method, which can determine that an installed dielectric is bad, but does not give conclusive evidence if the test indicates that the dielectric is good; and the power supply method, which can determine that an installed dielectric is good, but does not give conclusive evidence if the test indicates that an installed dielectric is bad.

CAUTION: Do not use an ohmmeter to measure resistance of an installed dielectric. If the dielectric is good, current will flow through the meter and damage could result. If that current does not damage the meter, the measurement would not indicate a resistance value. The voltage would be interpreted by the meter as coming from the internal battery instead of the external electrical circuit being measured.

6.7.1 TESTING FOR A SHORTED DIELECTRIC. Take a potential measurement of both sides of the installed dielectric by changing only the structure connection, without moving the copper/copper sulfate reference electrode.

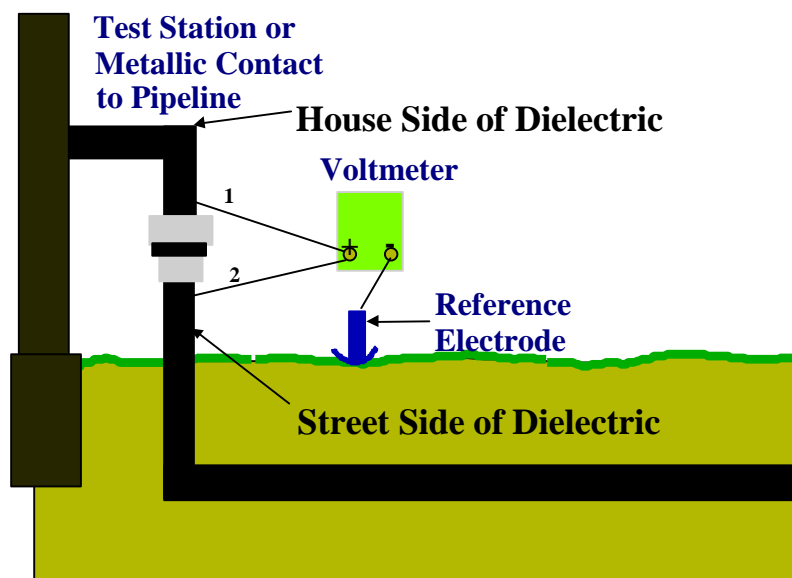

Figure 13

Testing for a Shorted Dielectric

- If the two potential measurements are significantly different (over 10 mV), the dielectric is good. The street side of the dielectric, under normal conditions (with cathodic protection) should be at a potential more negative than -0.85 volts DC and the house side of the dielectric should be between approximately -0.15 volts DC and -0.45 volts DC (a difference of between 400 and 700 mV). If the dielectric is good and the house side of the dielectric has a potential more negative than expected, another shorted dielectric in the area should be suspected, and further investigation is required (for example, if the house side potential reading is over -0.65, with a street side potential the same or more negative).
- If the two potential measurements are not significantly different (under 10 mV), the dielectric may be shorted and additional testing is required. The preferred method is to use a radio frequency tester (insulated flange tester) to test that specific dielectric. Other possible methods that may or may not be conclusive include using the pipe locator method or the power supply method.

6.7.2 USING A RADIO FREQUENCY TESTER. This method is the most accurate and conclusive method of testing a dielectric. Turn the insulated flange tester test switch to “zero,” turn the control knob on, and zero the needle indicator. Turn the test switch to “test,” and without turning the control knob, test the dielectric.

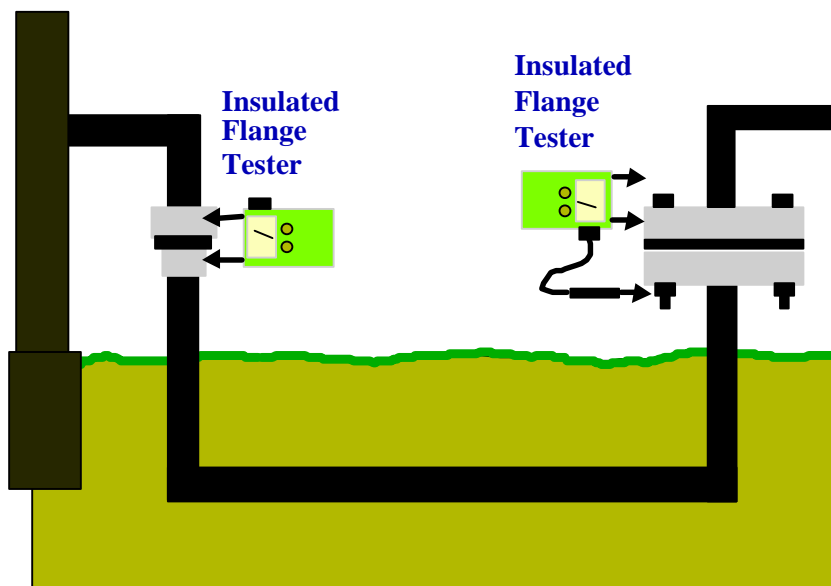

Figure 14

Testing an Installed Dielectric with the Insulated Flange Tester

6.7.3 USING A PIPE LOCATOR. Two different types of pipe locators may indicate that a dielectric is bad. One uses a short wave length signal and one uses the signal from an impressed current system (60-cycle “noise”—this method can only be used on impressed current systems with a single phase rectifier). These methods give a rapid indication if the dielectric is shorted, but may not be conclusive.

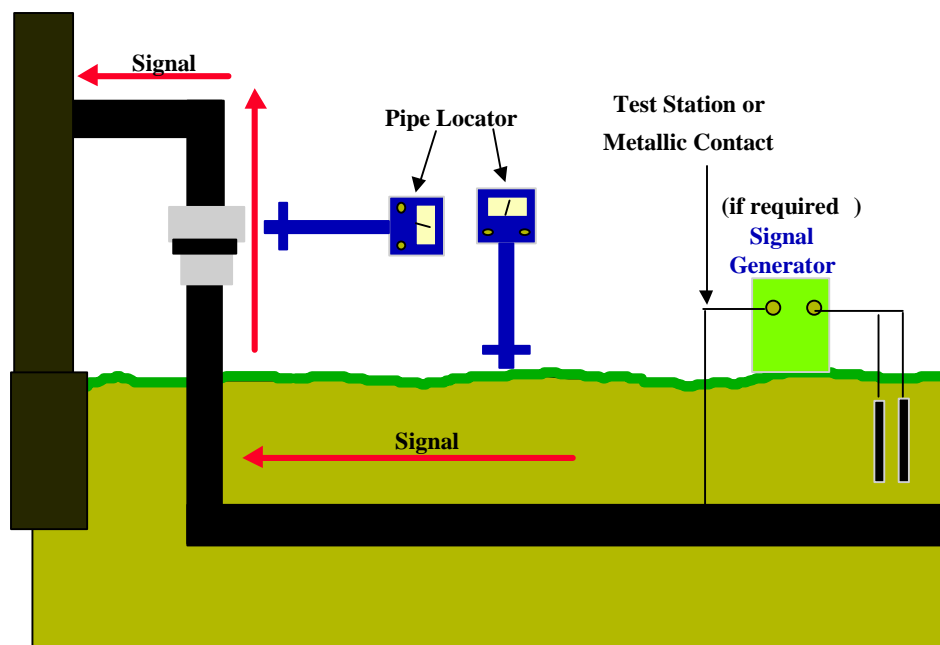

Figure 15

Testing for a Shorted Dielectric Using a Pipe Locator

The Pipe Horn, Model FDAC200, detects the signal from a single-phase rectifier. With the impressed current system on, this locator can be used to follow the underground pipeline. If a dielectric is shorted, and the current is sufficient, the locator will follow the signal across the dielectric. Consequently, if the signal is followed through the dielectric, that dielectric is bad. If no signal can be followed, verify with the insulated flange tester.

A short wave length pipe locator, using a direct connection, detects the signal from a signal generator. To obtain a strong signal, ensure that a good metallic connection is made, a good battery is installed in the signal generator, and most importantly, that the signal generator has a good, low resistant ground. This locator can then be used to follow the underground pipeline. If a dielectric is shorted, and the signal is sufficient, the locator will follow the signal across the dielectric. Consequently, if the signal is followed through the dielectric, that dielectric is bad. If no signal can be followed, verify with the insulated flange tester.

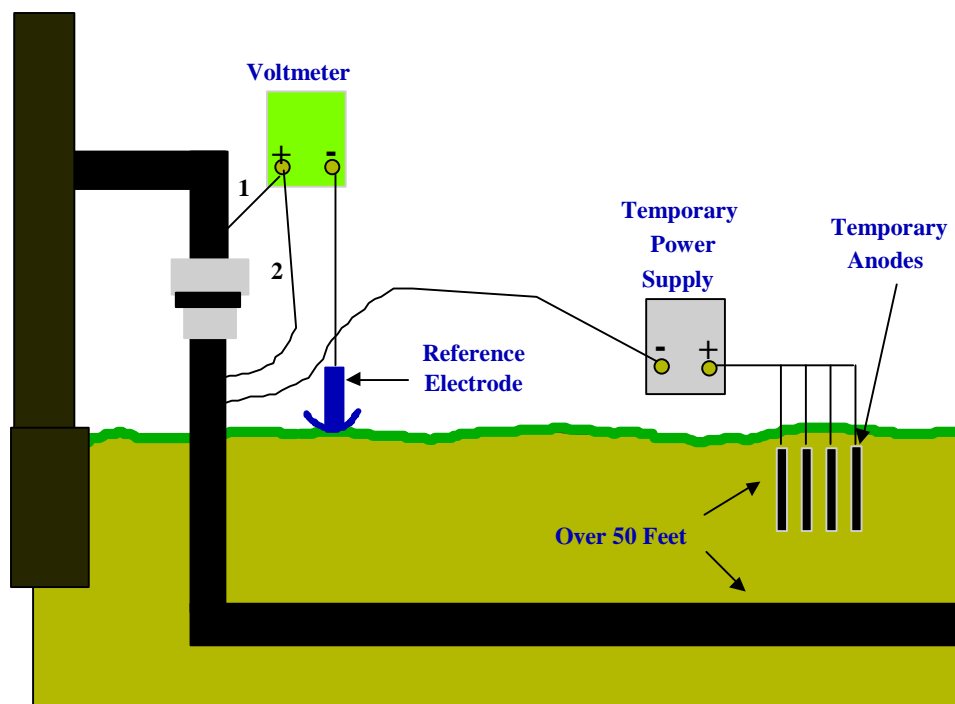

Figure 16

Testing for a Shorted Dielectric with Power Supply

6.7.4 USING A TEMPORARY LOCAL CATHODIC PROTECTION SYSTEM. Install a temporary local cathodic protection system to increase the current to the street side of the dielectric; or if possible, merely increase the current level of the existing system. Note that the temporary system should be installed where the current should distribute to the location being tested. Repeat the potential measurement of both structures. If the potential of the house side of the dielectric remains approximately the same or changes in a positive direction (less negative), when the potential of the street side of the dielectric changes in a negative direction, they are not shorted. If both potential measurements change more negative as current is increased, the two structures are shorted together.

6.8 CASING TESTS. Casings present a unique and sometimes very challenging problem to corrosion control. Although they are required in some cases, they present a serious problem to the application of cathodic protection to the carrier pipe. If not shorted, they may shield adequate protection; and if shorted, they totally shield the carrier pipeline and

steal the cathodic protection, often for a large area of the pipeline. The preferred method of corrosion control is to isolate and seal the casing so there is no electrolyte in the space between the casing and the carrier pipe, or fill that area with a nonconductive sealant. Casings are normally bare, while carrier pipelines are normally very well coated. Casings normally have vent pipes at one or both ends and a test station for corrosion control testing. This test station usually has four wires, two to the casing and two to the carrier pipeline. If there is not a test station already installed, one should be installed prior to testing. At a minimum, there must be a metallic connection made to the carrier pipeline and a vent pipe that is connected metallically to the casing. If there is no vent pipe or carrier pipe test point in the vicinity of the casing, you must excavate to the carrier pipeline or the casing, as required, and test connections. Again, a test station should be installed.

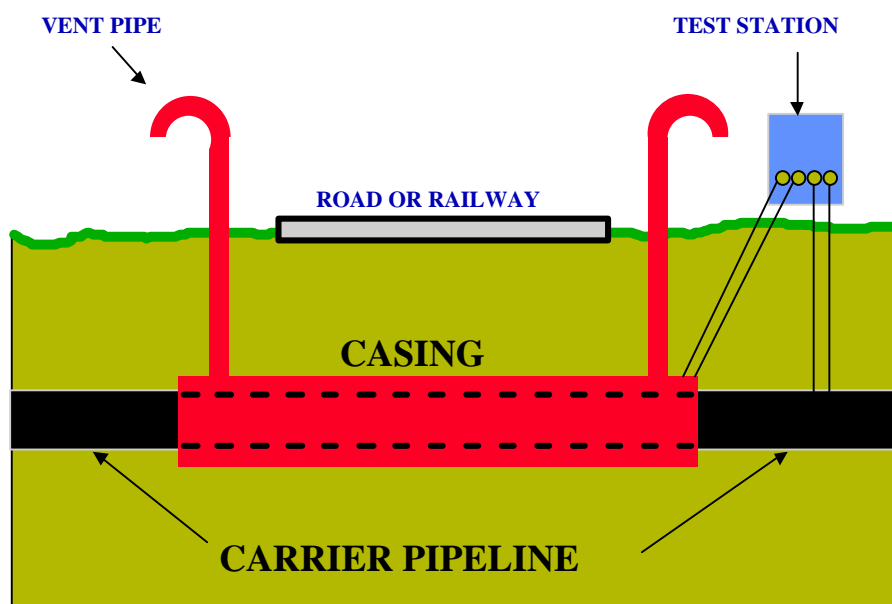

Figure 17
Typical Casing Installation

CAUTION: Do not use an ohmmeter to measure resistance between the carrier pipeline and the casing. If the isolation is good, current will flow through the meter and damage could result. If that current does not damage the meter, the measurement would not

indicate a resistance value. The voltage would be interpreted by the meter as coming from the internal battery instead of the external electrical circuit being measured.

6.8.1 TESTING A CASING WITH CATHODIC PROTECTION ON THE CARRIER PIPELINE. Take a potential measurement of the carrier pipeline and the casing by changing only the structure connection without moving the copper/copper sulfate reference electrode.

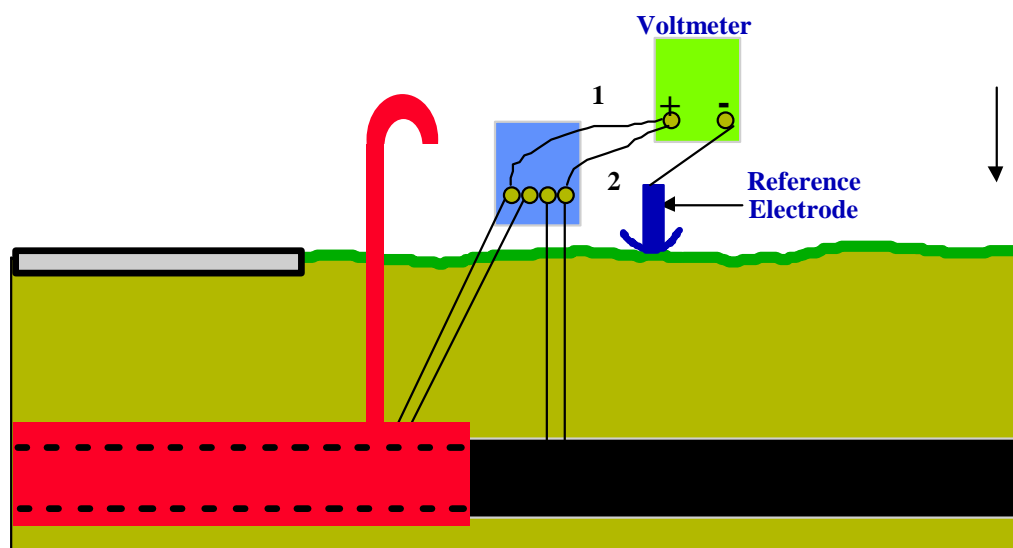

Figure 18
Testing for a Shorted Casing

- If the two potential measurements are significantly different (over 10 mV), the casing is not shorted to the pipeline. Under normal conditions, the carrier pipeline should be at a potential more negative than -0.85 volts DC, and the casing should be between approximately -0.35 and -0.65 volts DC (a difference of between 200 to 500 mV).
- If the two potential measurements are not significantly different (under 10 mV), the casing may be shorted to the pipeline and additional testing is required. Install a temporary local cathodic protection system to increase the current to the carrier pipeline or, if possible, merely increase the current level of the existing system.

Note that the temporary system must be installed on the opposite side of the railway or road crossing from the location of the potential testing. Repeat potential measurement of the carrier pipeline and the casing. If the potential of the casing remains approximately the same, or changes in a positive direction (less negative), when the potential of the carrier pipe changes in a negative direction, the insulation is good. If both the carrier pipeline and the casing potential measurements change more negative as current is increased, the carrier pipeline is shorted to the casing.

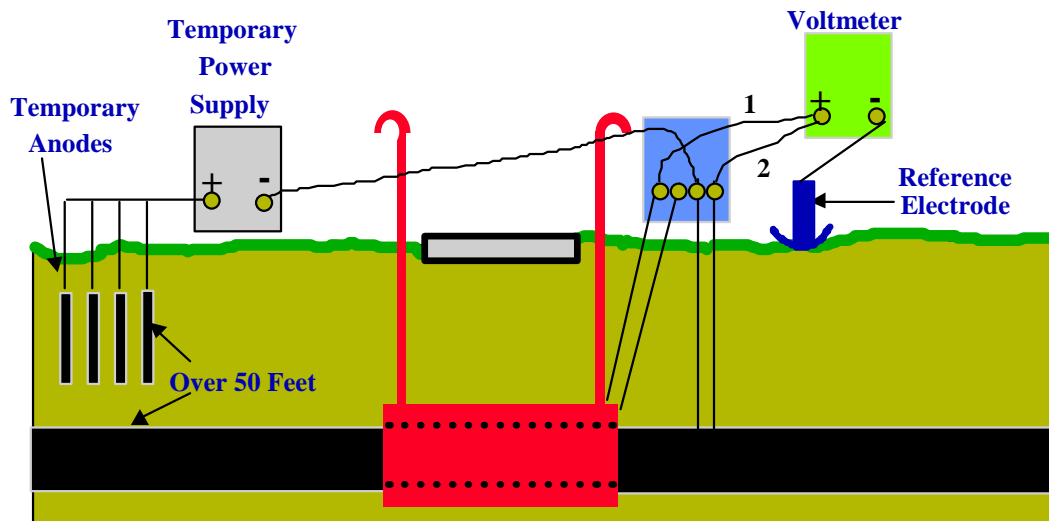

Figure 19

Testing for a Shorted Casing with Power Supply

6.8.2 TESTING A CASING WITHOUT CATHODIC PROTECTION ON THE CARRIER PIPELINE. Install a temporary local cathodic protection system to apply current to the carrier pipeline. Always install the temporary anodes on the opposite side of the crossing from the side where the potential measurements are taken. Take a potential measurement of the carrier pipeline and the casing by changing only the structure connection without moving the copper/copper sulfate reference electrode.

- If the two potential measurements are significantly different (over 10 mV), the casing is not shorted to the pipeline. With sufficient current applied to the carrier

pipeline, it should have a potential of approximately -0.85 volts DC and the casing should be between approximately -0.35 and -0.65 volts DC.

- If the two potential measurements are not significantly different (under 10 mV), the casing may be shorted to the pipeline and additional testing is required. Increase the amount of current applied to the carrier pipeline (by turning up power supply or adding additional temporary anodes), then repeat potential measurement of the carrier pipeline and the casing. If the potential of the casing remains approximately the same or changes in a positive direction (less negative) when the potential of the carrier pipe changes in a negative direction, the insulation is good. If both the carrier pipeline and the casing potential measurements change more negative as current is increased, the carrier pipeline is shorted to the casing.

6.9 TESTING FOR A SHORT BETWEEN TWO STRUCTURES. Shorts between two structures can adversely affect the operation of cathodic protection systems. If a protected structure is designed to protect an isolated structure, shorts to other structures will normally result in loss of adequate protection to that structure. Shorts may also result in the current distribution being adversely affected, and consequent loss of protection to areas of the structure. Determination of shorted or isolated conditions is also important in the design phase of cathodic protection installations. The preferred method for testing for a short between two structures is potential testing. This method will normally provide immediate indication if the two structures are not shorted, and at the same time provide valuable potential data. The methods of potential measurement will vary slightly if cathodic protection is supplied to neither structure, one structure or both structures. A power supply may be required if one or both structures do not have CP installed. If only one structure has CP, refer to the procedures recommended. If both structures have CP, refer to the procedures recommended. **CAUTION:** Do not use an ohmmeter to measure resistance between the two underground structures. If the structures are isolated, current will flow through the meter and damage could result. If that current does not damage the meter, the measurement would not indicate a resistance value. The voltage would be interpreted by the meter as coming from the internal battery instead of the external electrical circuit being measured.

6.9.1 TESTING FOR A SHORT BETWEEN TWO STRUCTURES WITH CATHODIC PROTECTION ON ONE STRUCTURE. Take a potential measurement of both structures by changing only the structure connection without moving the copper/copper sulfate reference electrode.

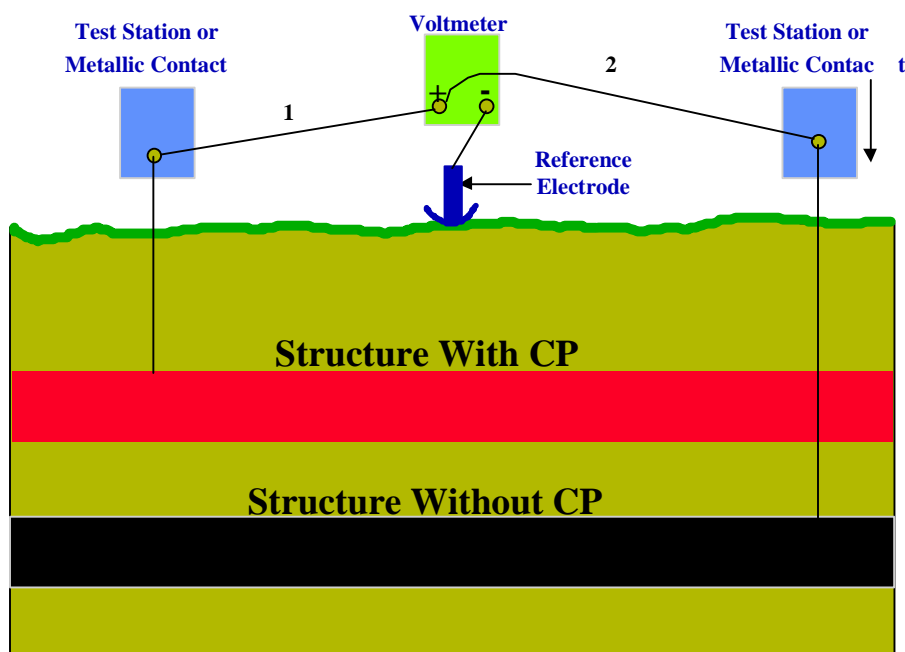

Figure 20

Testing For A Short Between Two Structures

- If the two potential measurements are significantly different (over 10 mV), the two structures are not metallically shorted together. Under normal conditions, the structure with cathodic protection should be at a potential more negative than -0.85 volts DC and the steel structure without cathodic protection should be between approximately -0.35 volts DC and -0.65 volts DC (a difference of between 200 to 500 mV). If the other structure is copper or steel in concrete under normal conditions, it should have a potential between approximately -0.20 volts DC and -0.30 volts DC.

- If the two potential measurements are not significantly different (under 10 mV), the two structures may be shorted, and additional testing is required. Install a temporary local cathodic protection system to increase the current to the carrier pipeline or, if possible, merely increase the current level of the existing system. Note that the temporary system should be installed where the current should distribute to just one structure. Repeat the potential measurement of both structures. If the potential of the unprotected structure remains approximately the same or changes in a positive direction (less negative), when the potential of the protected structure changes in a negative direction, they are not shorted. If both potential measurements change more negative as current is increased, the two structures are shorted together.

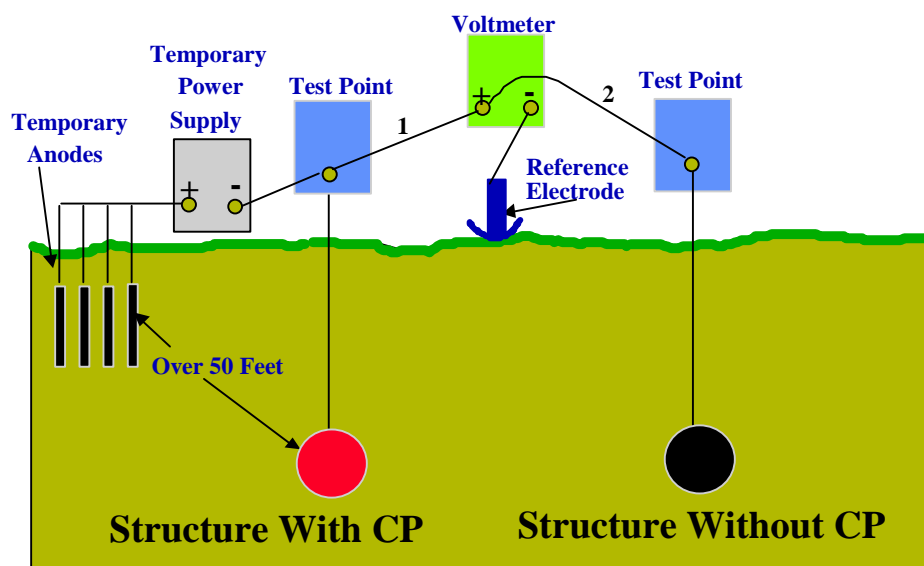

Figure 21

Testing for a Short Between Two Structures with Power Supply

6.9.2 TESTING FOR A SHORT BETWEEN TWO STRUCTURES WITH CATHODIC PROTECTION ON BOTH STRUCTURES. Take a potential measurement of both structures by changing only the structure connection without moving the copper/copper sulfate reference electrode.

- If the two potential measurements are significantly different (over 25 mV), the two structures are not metalically shorted together. Under normal conditions, both structures should have a potential more negative than -0.85 volts DC.
- If the two potential measurements are not significantly different (under 25 mV), the two structures may be shorted and additional testing is required.
- If one or both of the protected structures have impressed current systems, turn off the rectifier on one system. Repeat the potential measurement of both structures. If the potential of the structure with the rectifier still on remains approximately the same or changes in a negative direction when the potential of the structure with the rectifier off changes in a positive direction (less negative), they are not shorted. If both potential measurements change more positive approximately the same magnitude when one system's current is interrupted, the two structures are shorted together.

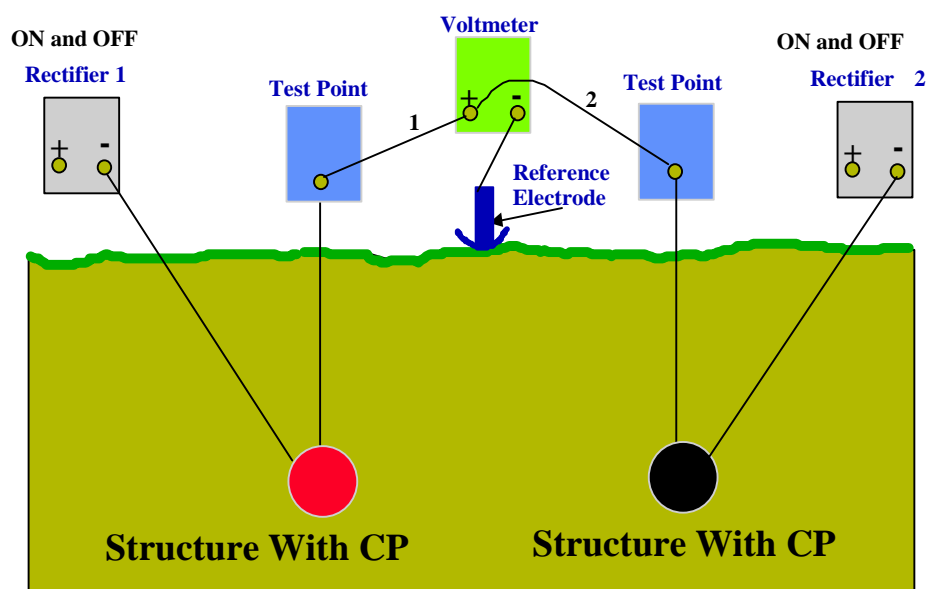

Figure 22

Testing for a Short Between Two Structures with Cathodic Protection on Both Structures

System Condition		Expected Potential	
System Shorted			
Rect. 1	Rect. 2	System 1	System 2
ON	ON	-0.955	-0.965
ON	OFF	-0.745	-0.750
OFF	OFF	-0.550	-0.550
OFF	ON	-0.750	-0.750
System Not Shorted, No Interference			
Rect. 1	Rect. 2	System 1	System 2
ON	ON	-0.955	-0.965
ON	OFF	-0.955	-0.555
OFF	OFF	-0.545	-0.555
OFF	ON	-0.545	-0.965
System Not Shorted, With Interference			
Rect. 1	Rect. 2	System 1 (Discharge Area)	System 2 (Pickup Area)
ON	ON	-0.955	-0.965
ON	OFF	-0.965	-0.565
OFF	OFF	-0.545	-0.555
OFF	ON	-0.535	-0.955

Table 2

Expected Potential Example under Shorted/Not Shorted Conditions

If both systems have impressed current systems and a clear indication of the shorted condition has still not been identified, repeat previous test procedure leaving the first

system's rectifier on and interrupting the second system's rectifier. If the potential of the structure with the rectifier still on remains approximately the same or changes in a negative direction when the potential of the structure with the rectifier off changes in a positive direction (less negative), they are not shorted. If both potential measurements change more positive approximately the same magnitude (less negative) when one system's current is interrupted, the two structures are shorted together. If both systems have impressed current systems and a clear indication of the shorted condition has still not been identified, turn off both rectifiers and follow procedures recommended.

6.9.3 TESTING FOR A SHORT BETWEEN TWO STRUCTURES WITHOUT CATHODIC PROTECTION ON EITHER STRUCTURE. Take a potential measurement of both structures, by changing only the structure connection, without moving the copper/copper sulfate reference electrode.

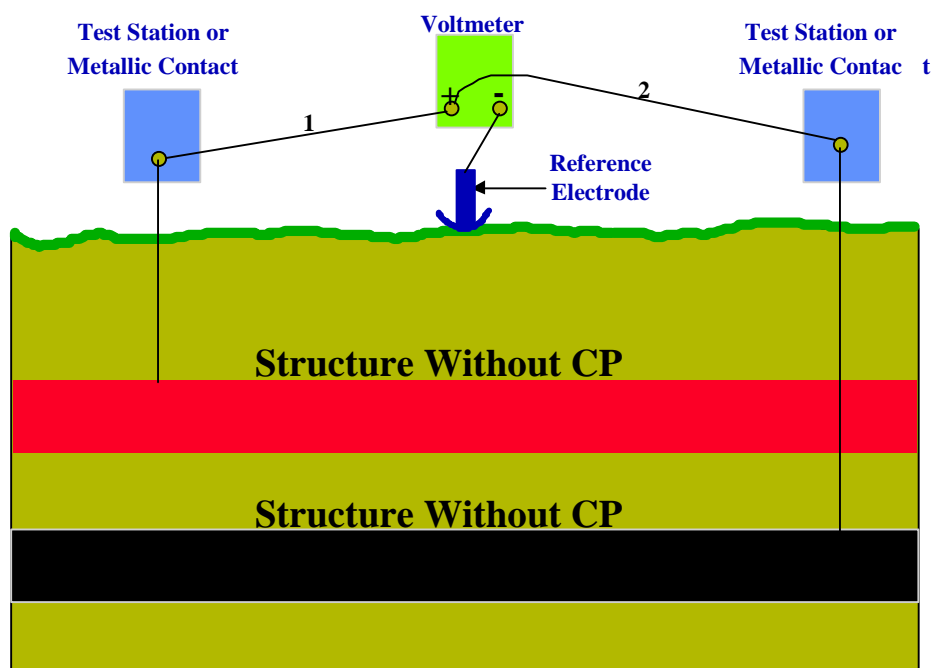

Figure 23

Testing for a Short between Two Structures without Cathodic Protection on Either Structure

- If the two potential measurements are significantly different (over 25 mV), the two structures are not metalically shorted together. Under normal conditions, steel structures should have a potential between approximately -0.35 volts DC and -0.65 volts DC. If a structure is copper or steel in concrete under normal conditions, the potential should be between approximately -0.20 volts DC and -0.30 volts DC; and if a structure is galvanized (zinc-coated), the potential should be between approximately -0.80 volts DC and -1.05 volts DC.
- If the two potential measurements are not significantly different (under 25 mV), the two structures may be shorted and additional testing is required. Install a temporary local cathodic protection system to apply current to one of the structures to be installed where the current should distribute equally to both structures.
- Repeat the potential measurement of both structures. If the potential of the structure without the current being applied to it remains approximately the same or changes in a positive direction (less negative) when the potential of the structure with current applied changes in a negative direction, they are not shorted. If both potential measurements change more negative as current is increased, the two structures are shorted together.

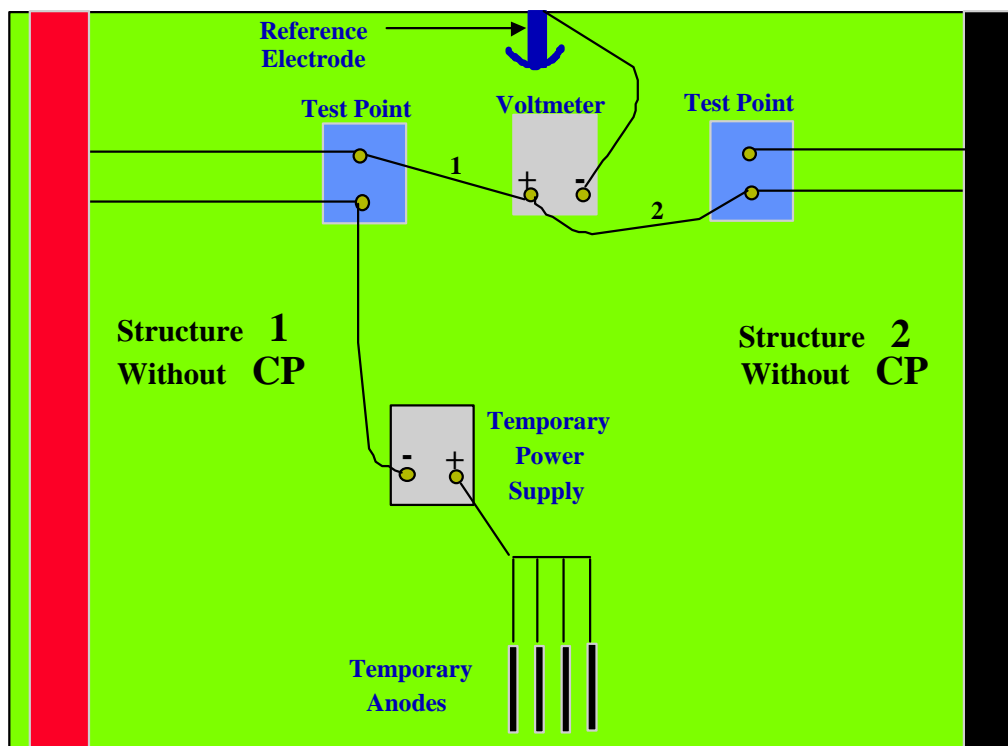

Figure 24

Testing for a Short Between Two Structures with Power Supply

6.10 CURRENT REQUIREMENT TESTING PROCEDURES. Current requirement testing is conducted when planning a cathodic protection system installation to determine the type and size of the system required. If the system design requires isolation of the structure to be protected, that isolation must be accomplished prior to the current requirement test. The current requirement for a non-isolated structure does not give any indication of what the current requirement would be if the structure were isolated. Temporary systems are used to determine the effect of current applied on the potential of the structure being tested. Actual protection need not be accomplished to estimate the amount of current required. Portable rectifiers should be used together with temporary anodes (usually ground rods) or existing metallic structures to impress a test current to the structure. Vehicle batteries can be used, as well as spare rectifiers, DC generators, DC welding units, or rectifiers from other systems can be temporarily removed for use.

6.10.1 TEMPORARY LOCAL CATHODIC PROTECTION SYSTEMS. Temporary local cathodic protection systems should be located in areas where the intended installation is to be located, if known. If not known, they should be located as remote as possible from the structure to be protected, without any foreign structures in the area of the temporary anode bed, and without any foreign structure between the temporary anode bed and the structure to be protected.

WARNING: Do not use any metallic structure for a temporary anode that is shorted to the structure being tested. This will result in very large current surges that can cause injury to personnel and damage to equipment. For Navy projects, when conducting work on or near circuits' energized lines or parts of equipment operating at or above 50V, utilize work practices identified in OPNAV P-45-116-98.

6.10.2 EXISTING METALLIC STRUCTURES. Existing metallic structures, such as metal fences, culverts, abandoned pipelines, or abandoned wells can be used as temporary anodes or to supplement installed temporary anodes. If any existing structure is to be used, it should first be tested to see if that structure is shorted to the structure to be tested. The area of the temporary installation should be well scouted to determine if any possible temporary anodes exist or if any foreign structure is in the area. Do not use pipelines or tanks for temporary anodes that would be adversely affected if leaks occurred.

6.10.3 TEMPORARY ANODES. The number of temporary anodes required depends on the available voltage source, the amount of current desired, and the resistivity of the soil. If the number of anodes is doubled, the amount of current is approximately doubled. If the soil resistivity is doubled, the current is cut in half. In very low resistivity soil, two or three anodes may be sufficient, and in very high resistivity soil, a high number of temporary anodes may be required. The amount of current desired depends basically on the quality of the coating on the structure being tested. Very well-coated structures will exhibit a noticeable potential change with a small amount of current (1 or 2 amps), while poorly-coated structures will not exhibit a noticeable potential change except with a large amount of current (10 to 20 amps). If the voltage is doubled, the current is doubled.

Consequently, if the voltage source is low, more temporary anodes will be required, if the voltage source is very high, only a few temporary anodes will be required.

6.10.4 INSTALLATION OF TEMPORARY ANODE SYSTEM. The installation of a temporary anode system is often required to perform current requirement testing. Normally copper ground rods are used. Any metallic ground rod can be used as well as any metallic pipe or conduit. Streams, ponds, rivers, lakes, bays, oceans, or other standing water in the area of the temporary anode location make an ideal location for obtaining a low resistance-to-earth anode bed. In these wet locations, the ground rods can be simply laid in the water. Normally ground rods are cut in half to make 4- to 5-foot sections. These ground rods (or metallic pipe or conduit), are sharpened and driven into the ground until approximately 0.3 meters (one foot) are above the ground level. These rods should be installed approximately 4.5 to 6 meters (15 to 20 feet) apart to lower the resistance to earth. In high resistivity areas, when higher test current is required, water sprinklers can be used over a period of time to lower the resistance. In extreme cases, an excavation can be made, then small diameter steel pipe can be pushed into the earth with a backhoe or bulldozer. This method can also be used to simulate a deeper installation. It is possible to install 9 to 18 meters (30 to 60 feet) in this manner if there are no rock formations.

CAUTION: Do not connect the structure being tested to the positive terminal of the power source. Severe corrosion of the structure may result.

6.10.5 CONNECTIONS. The temporary anodes all must be connected to the power source positive terminal. The structure being tested must be connected to the negative terminal. For physical strength and low resistance, #6 AWG copper cable or larger must be used and #2 AWG or greater is desired, especially if long runs in either the structure or anode cable are needed. Connections can be made with pipe clamps, test clamps of sufficient size, split bolts, and exothermic welding. All wire and connections must be made to accommodate the voltage and current required for the testing. The normal portable rectifier is 60 volts at 30 amps or 30 volts at 60 amps. Other rectifiers may be over 180 volts or 100 amps.

6.10.6 BEFORE APPLYING POWER. Before any power is applied, it is essential to obtain the as-found potential data of the structure. The native potential must be tested for all locations to be tested during the current requirement test, to obtain the potential shift accomplished by the test current.

6.10.7 APPLYING POWER. Beginning at a low voltage setting, turn power on, ensure the potential shift of the structure is in the negative direction. Gradually increase voltage and current to desired output, while periodically checking potential to ensure a corresponding negative shift as current is increased. If maximum voltage is reached and more current is still required, turn system off and supplement the temporary anode bed.

6.10.8 SUFFICIENT CURRENT. Sufficient current is applied when a substantial section of the structure to be tested has achieved a noticeable potential shift or when full protection is achieved. If full protection is achieved, the current requirement is the same as the test current. If full protection is not achieved, further calculations are required.

6.10.9 CALCULATING CURRENT REQUIREMENTS. Once the potential shift is ascertained, and the current to get that shift is known, the current requirement can be calculated. If the current is doubled, the potential shift is doubled. Current distribution should be considered: If good current distribution is achieved, a simple mathematical formula will produce the current requirement. If proper current distribution is not achieved, it must be designed into the system. If the design will call for a deeper anode bed, current requirement can be estimated by calculations. If the design is for surface beds, additional cathodic protection systems should be considered and further current requirement testing for additional locations conducted.

6.10.10 MORE THAN ONE ANODE BED. If a current requirement test includes more than one anode bed location; all current sources should be interrupted simultaneously to measure the potential shift of the structure. The total current requirement is found by adding the current from all power sources together. Always consider proper current distribution and estimate the required current requirement for each individual system.

6.10.11 COMPLETION OF TESTING. Upon completion of testing, turn all power sources off, disconnect all cables, and remove temporary anodes. For ease of removal of ground rods or small diameter pipes and conduit, use three flat metal bars as shown in Figure 25.

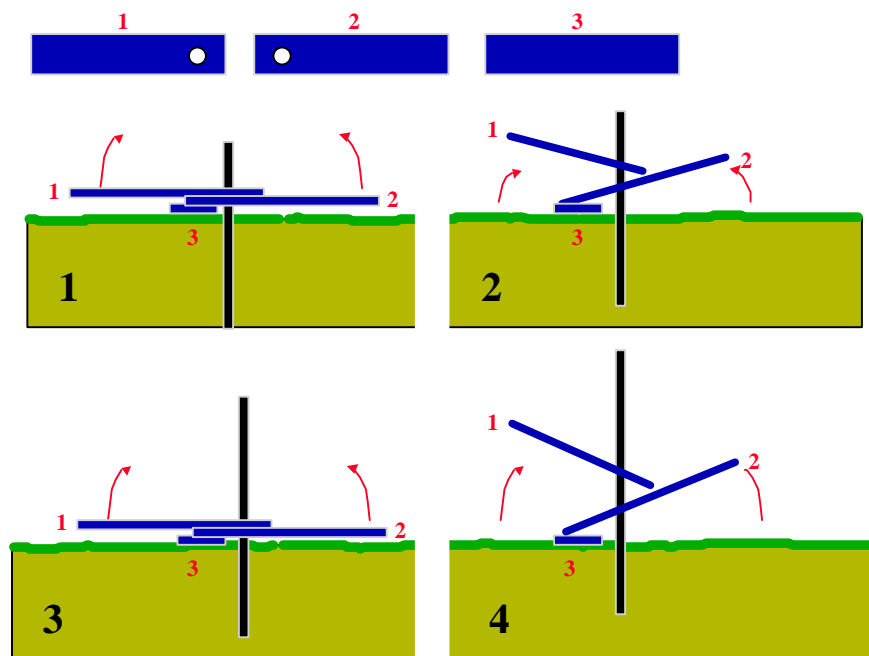

Figure 25

Removing Temporary Anodes (Ground Rods)

6.11 ELECTROLYTE RESISTIVITY MEASUREMENT. Resistivity is the property of a material that determines the electrical resistance between two points within the material. The most common units of resistivity are ohm-centimeters and ohm/cubic centimeters, which are equivalent. Many factors in the operation of cathodic protection systems are dependent upon the resistivity of the electrolyte. The corrosivity of the environment is generally higher when the resistivity is low. The output of both sacrificial anodes and impressed current anodes is also dependent upon the resistivity of the environment. The resistivity of fresh water and seawater normally does not change sufficiently to affect the operation of cathodic protection systems. However, the resistivity of soil environments depends upon the amount of moisture present and is subject to wide variations. These commonly experienced variations in soil resistivity affect the operation of cathodic

protection systems, manifesting in variations in structure-to-electrolyte potentials or rectifier outputs measured during routine system inspections. Electrolyte resistivity measurements are taken to determine the cause of improper system operation.

6.11.1 FOUR-PIN METHOD. The most commonly used method of measuring soil resistivity is the four-pin method. A current is passed through two electrodes, and a drop in potential through the soil due to the passage of the current is measured with a second pair of electrodes. A specialized instrument is used to supply the current and measure the potential drop. To reduce the influence of any stray currents in the area, the instrument supplies alternating current. The arrangement of electrodes is shown in Figure 26.

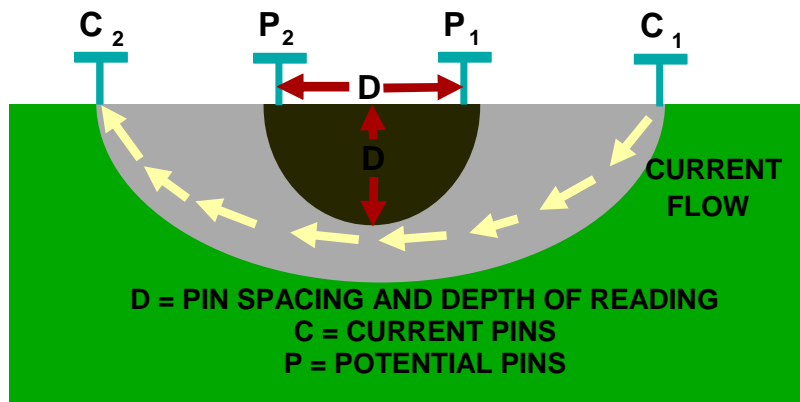

Figure 26

Soil Resistivity by the Four Pin Method (Wenner)

The soil resistivity is calculated from the indicated reading by using the following formula:

$$\text{Resistivity (ohm-cm)} = 191.5 \times \text{pin spacing (in feet)} \times \text{meter reading}$$

In this method, the average resistivity of the soil between the two center electrodes to a depth equal to the pin spacing is measured. If the pin spacing is increased, then the average soil resistivity to a greater depth is measured. If the average resistivity increases as the pin spacing increases, then there is a region of higher soil resistivity at depth. If the average soil resistivity decreases with depth, then there is a region of lower soil

resistivity at depth. For multipliers for common distances and distances for even multipliers, see Table 2.

Common Distances		Even Multipliers	
Distance Between Rods	Reading Multiplier	Distance Between Rods	Reading Multiplier
2'6"	479	2'7"	500
5'	958	5'3"	1000
7'6"	1,436	7'10"	1,500
10'	1,915	10'5"	2,000
12'6"	2,394	13'1"	2,500
15'	2,872	15'8"	3,000
20'	3,830	20'11"	4,000
30'	5,745	31'4"	6,000

Table 3

Four-Pin Soil Resistivity Measurement Reading Multipliers

6.11.2 TWO-PIN METHOD. In the two-pin method of soil resistivity measurement, the potential drop is measured between the same pair of electrodes used to supply the current. The equipment used to make this type of measurement is often called the “Shepard’s Canes,” after its inventor. As shown in Figure 27, the probes are placed 0.3 meters (one foot) apart. If the soil is too hard for the probes to penetrate, the reading is taken at the bottom of two augured holes. The instrument is calibrated for a probe spacing

of one foot and gives a reading directly in ohm-cm. Although this method is less accurate than the four-pin method and measures the resistivity of the soil only near the surface, it is often used for preliminary surveys, as it is quicker than the four-pin method.

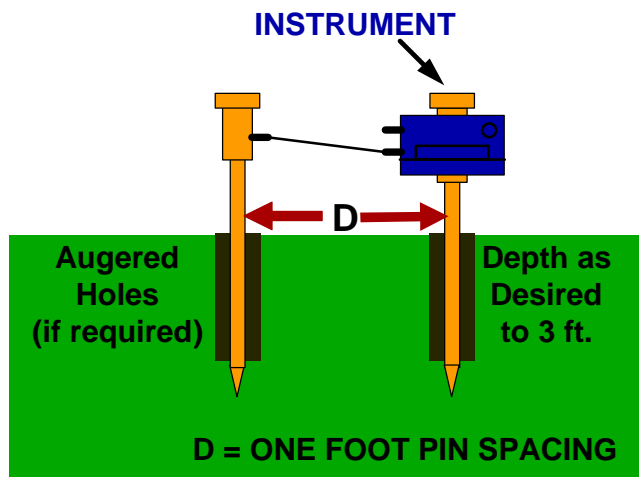

Figure 27

Two-Pin Method (“Shepard’s Canes”) of Soil Resistivity Measurement

6.11.3 OTHER METHODS (SOIL ROD, SOIL BOX). A soil rod is essentially a two-pin resistivity-measuring device where the electrodes are both mounted on a single rod, as shown in Figure 28. As in the other two-pin method, the resistivity of the soil to a very shallow depth is measured. Also, the soil must be soft enough to allow penetration of the rod. Measurements using the soil rod, however, can be taken quickly when measuring in soft soil.

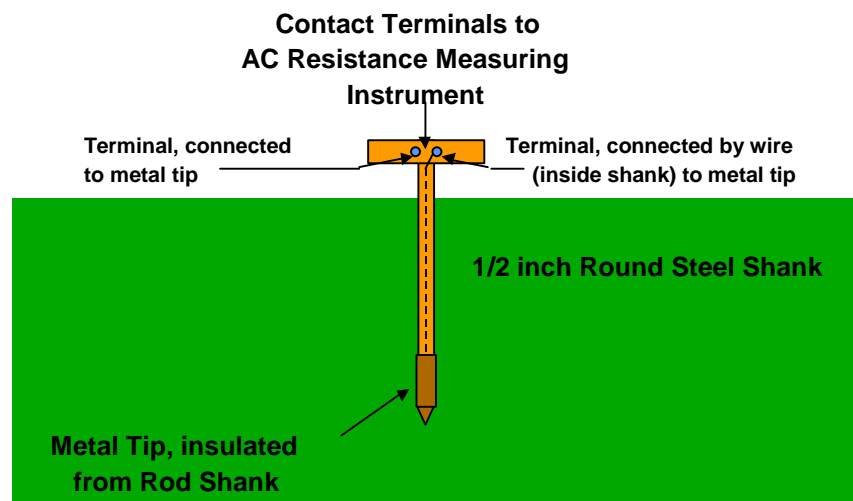

Figure 28

Soil Resistivity Measurement Using a Soil Rod

When it is impractical to make field measurements of soil resistivity, soil samples can be taken and the resistivity of the sample can be determined by using a soil box. As shown in Figure 29, the method of measurement is essentially the four-pin method. Metal contacts in each end of the box pass current through the sample.

Potential drop is measured across probes inserted into the soil. The resistivity is calculated using constants furnished with the particular size of soil box being used. Due to the disturbance of the soil during sampling and possible drying out of the soil during shipment, this method of soil resistivity measurement is less likely to represent true, in-place soil resistivity than an actual field test. To minimize drying out of samples, they should be placed in plastic bags and sealed prior to shipment.

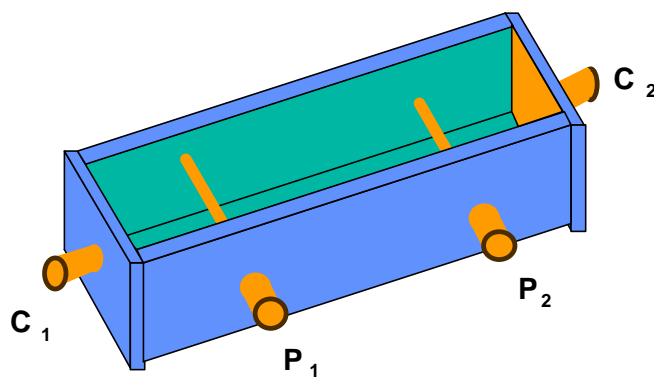

Figure 29

Soil Resistivity Measurement Using a Soil Box

6.12 pH TESTING PROCEDURES. The pH of an electrolyte is a measure of the acidity or alkalinity of the electrolytic solution. pH ranges from 0 to 14 with 0 to 7 being acidic, 7 being neutral and 7 to 14 being alkaline. pH can be measured using several methods. The pH of an electrolyte—the state of active acidity or alkalinity—is a major factor that determines the rate at which metals will corrode. Acid solutions have more hydrogen (H⁺) ions than hydroxyl (OH⁻) ions. The electrolyte pH is tested for planning, design considerations, and leak surveys. For steel, the corrosion rate remains fairly constant, from a pH of about 4.5 to a pH of about 10.5. At a pH below 4, the corrosion rate for steel is drastically accelerated. Also, above a pH of 11, the corrosion rate for steel is drastically lower, except for a sharp rise when the pH approaches 14 (not shown in Figure 30). For aluminum, acidic corrosion rates are similar to steel, but unlike iron and steel, aluminum also shows accelerated corrosion attack in alkaline electrolytes (above a pH of 8.5) because of a reaction of Al⁺ ions with OH⁻ ions (see *amphoteric*).

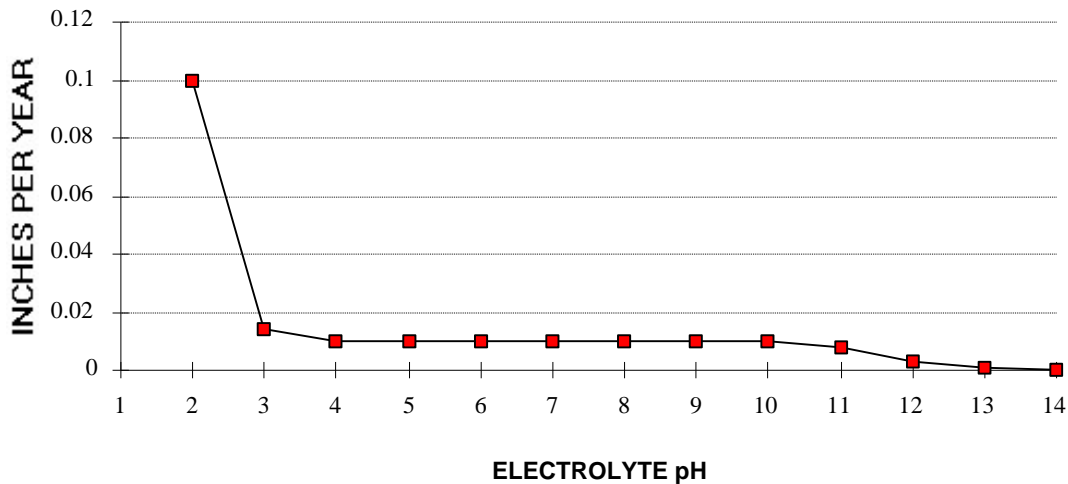

Figure 30
Effect of pH on the Corrosion Rate of Steel

6.12.1 ANTIMONY ELECTRODE TEST METHOD

Antimony is a unique metal with the characteristic of a direct relationship between pH and its measured potential. The potential difference or voltage developed between antimony and a copper/copper sulfate reference electrode varies from approximately 0.1 volts DC to 0.7 volts DC due to variations in the pH. Consequently, it can be used to determine the pH of the electrolyte when used together with this reference electrode.

The antimony electrode must be cleaned prior to use. As with the copper/copper sulfate electrode, special cleaning procedures must be used. Clean the antimony electrode as per instructions in 6.2.1.1a. Antimony is very brittle; treat it carefully. The antimony tip must be kept smooth, and there must be no rough surface or pits.

ANTIMONY ELECTRODE

TOP CONNECTION

VOLTAGE/pH

BODY

ANTIMONY

ELECTRODE

SCALE

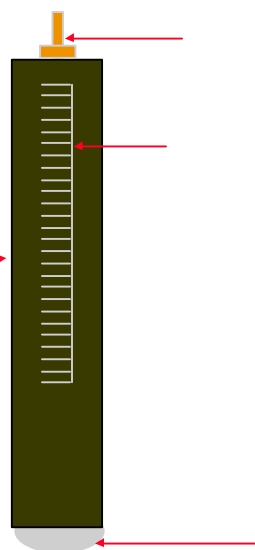

Figure 31

Antimony Electrode

Place the antimony electrode and the copper/copper sulfate half-cell in contact with the electrolyte and measure the potential difference using a high input resistance voltmeter. The measurement takes several seconds to stabilize. This stabilization is much slower in acid solutions than in alkaline solutions. Avoid taking these measurements with cathodic protection current on. Current flow in the electrolyte will affect the accuracy. If current flow cannot be stopped, place the two electrodes close together, perpendicular to the direction of current flow.

To measure for the presence of any current flow in the electrolyte, place one copper/copper sulfate half-cell and a second copper/copper sulfate half-cell a few inches apart in contact with the electrolyte, and measure the potential difference using a high input resistance voltmeter. Take measurements in several directions. If no current is present, the measurements will read the same; if current is present, the lowest measurement will be where the least amount of current is flowing. Also, if no current is flowing in the electrolyte, the measurement taken should be the same as the measurement taken by placing the two cells tip-to-tip, without touching the electrolyte.

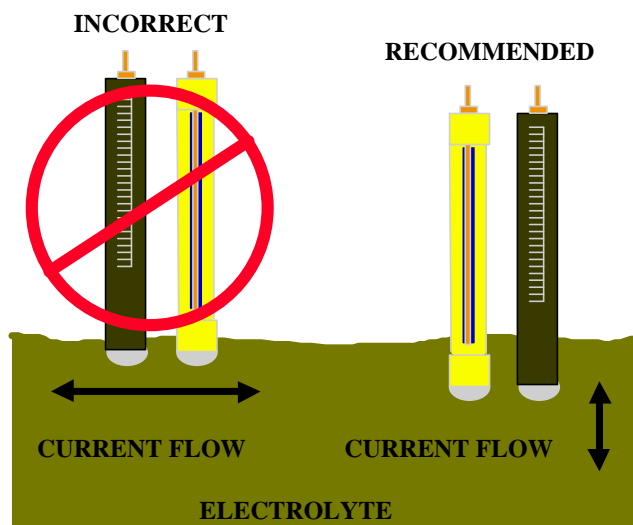

Figure 32
pH Measurement with Electrolyte Current Flow

6.12.2 CHEMICAL TEST METHOD. Chemical test methods are usually associated with liquid electrolyte samples. Chemical methods of measuring pH involve either the use of pH measuring electrodes or indicators whose colors are dependent on pH. A pH meter measures the difference in potential between a pH-insensitive reference electrode and an electrode whose potential is sensitive to pH. Colored indicators are normally used in the form of pH papers. The paper is wetted with the solution being measured and the resulting color is compared with color standards to determine the pH. When chemical meters or indicators are used to measure the pH of soil, the following procedure is used: a small amount of soil is (one or two tablespoons) placed in a clean container and an equal amount of water is added; after stirring, the mixture is allowed to settle and the pH of the liquid is measured.

6.13 CALIBRATION OF IR DROP TEST SPAN. The IR drop test span is a type of cathodic protection test station that is vital for determination of the direction and magnitude of DC current flowing through a pipeline. In protected pipelines, this information can be used to verify current distribution, look for stray or interference current, and the area of influence of installed rectifiers. In unprotected pipelines, this information

can be used to find anodic areas, and to find discharge or pickup areas of stray or interference currents. This method uses the metallic pipeline or cable as a shunt, which is then calibrated and used to measure a millivolt “IR Drop,” from which the current can be calculated. A known amount of DC current is applied to the pipeline and the voltage drop across the length is measured. The resistance can be estimated if the size of the pipeline and distance of the test span is accurately known. The line current can be determined by the null ammeter method, using a Multi-Combination meter. One other method for determining the direction and magnitude of DC current flowing through a pipeline is to use a clamp-on milliammeter. This method requires a very specialized piece of equipment, sized to the pipeline, and an excavation or access to the pipeline, for placement of the probe around the pipeline.

The preferred method is to measure the actual resistance of the pipe, using test current. This method does not require knowledge of the pipeline size or wall thickness, and is not affected by variations in the metal due to composition or corrosion, variations of resistance due to temperature, or inaccurate lengths of the test span. The amount of test current required depends on the diameter of the pipeline and the distance of the test span. The larger the pipeline, the larger the amount of current required. The shorter the distance of the test span, the larger the amount of current required.

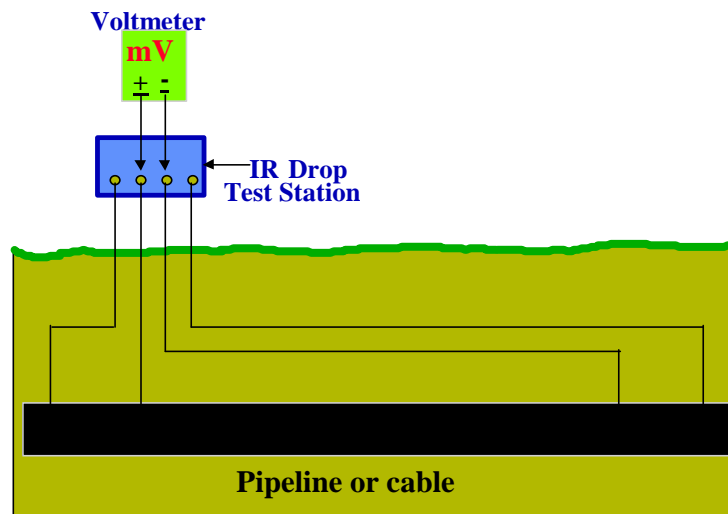

Figure 33
Typical IR Drop Test Span Installation

CAUTION: Do not use an ohmmeter to measure the resistance of the pipeline or cable. The current flowing on pipeline or cable will flow through the meter and damage could result. If that current does not damage the meter, the measurement would not indicate a resistance value. The voltage would be interpreted by the meter as coming from the internal battery instead of the external electrical circuit being measured.

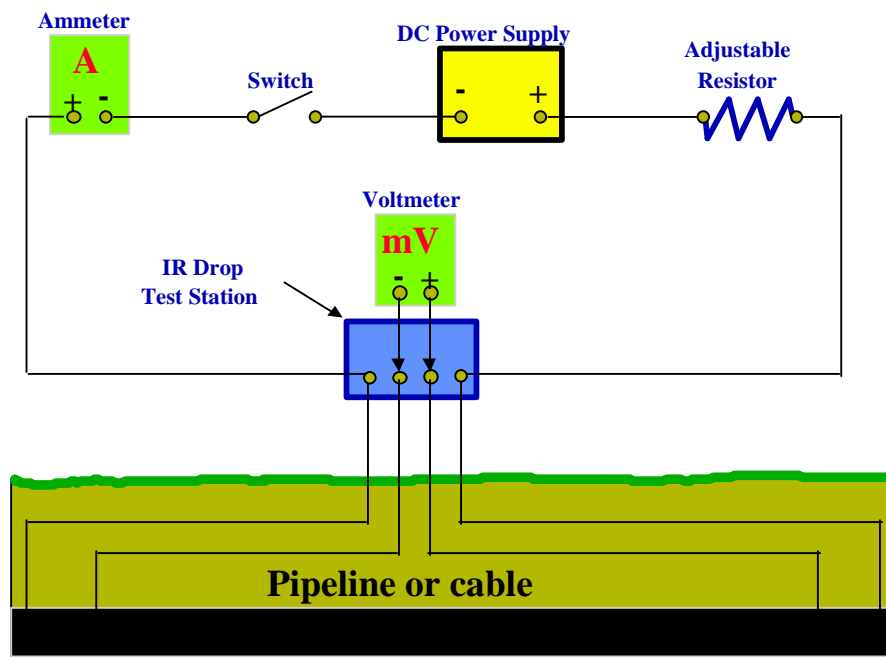

Figure 34
Calibration of an IR Drop Test Span

6.13.1 MEASUREMENT CIRCUITS. Calibration of an IR Drop test span involves two measurement circuits. The outside circuit comprises an ammeter to measure the current, a DC power supply, an on/off switch and some means of adjustment. A portable rectifier may be used as the current source, switch, and the means of adjustment. The inside circuit is a high input resistance voltmeter (minimum of 10 megaohms), set to the millivolt scale. Pipelines and cables inherently will have current flowing at all times. Therefore, a change in voltage drop measurement is compared to the amount of test current applied.

- Following all polarities in Figure 34, connect all circuit components. Polarity is important for correct determination of the direction of the current flow in the pipeline or cable during subsequent test procedures.
- With the outside circuit switch off, record the mV measurement of the inside circuit.
- Starting at a low current level, turn the outside circuit switch on and adjust current up to the desired test current. Record the measurement of the test current.
- With outside circuit remaining on, record the mV measurement of the inside circuit.
- Apply this data to the following formulas:

$$\text{Resistance} = \frac{\text{Voltage On} - \text{Voltage Off}^*}{\text{Test Current Applied}}$$

$$\text{Factor} = \frac{\text{Test Current Applied}}{\text{Voltage Change}^*}$$

*Voltage change must consider polarity. For example: 4.1 mV ON minus 1.3 mV OFF yields a voltage change of 2.8 mV; whereas 4.1 mV ON minus -1.3 mV OFF yields a voltage change of 5.4 mV (+ mV ON - -mV OFF = +mV ON + mV OFF = Voltage Change).

Record the resistance of the test span and the calibration factor established. If the temperature of the pipeline or cable remains constant, this calibration factor can be stenciled on the IR drop test station and used for future measurements. If doubt exists or temperatures change, perform the calibration steps each time measurements are taken.

6.13.2 DIRECTION OF CURRENT FLOW. Direction of current flow is determined by the polarity of the mV reading taken on the inside circuit. For example, using Figure 35, a positive IR drop indicates current flow from right to left, while a negative IR drop would indicate current flow from left to right.

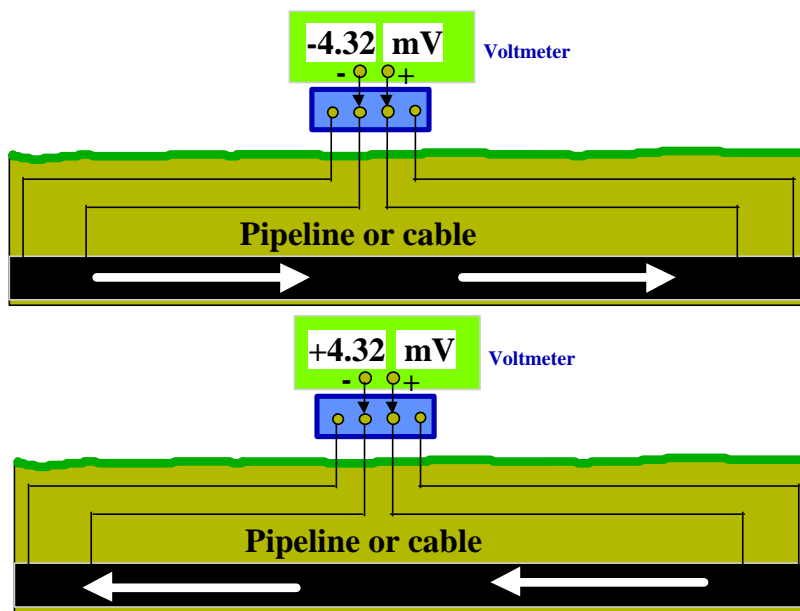

Figure 35

IR Drop Test Span, Direction of Current Flow

6.13.3 RESISTANCE OF THE PIPELINE. The resistance of the pipeline can be calculated if the distance of the test span is known and the size of the pipeline is accurately known. Resistance joints or insulators cannot be present on the pipeline in the test span. Variations in temperature will adversely affect the accuracy of these calculations.

The mV IR drop is measured by using a voltmeter on the mV scale as shown in Figure 35. Following all polarities in Figure 35, connect the meter to the inside circuit and record the measurement. Polarity is important for correct determination of the direction of the current flow in the pipeline or cable during subsequent test procedures.

The resistance is estimated using Table 3. The resistance is given in millionths of an ohm (0.000001 ohms) per linear foot of pipeline. This resistance value must be multiplied by the number of feet in the test span (distance in feet of the pipeline between the actual connection points of the test station leads to the pipeline).

Nominal Pipeline Size (inches)	Outside Diameter (inches)	Wall Thickness (inches)	Weight per Foot (pounds)	Resistance per Foot (micro ohms)
2	2.375	0.154	3.65	79.20
4	4.500	0.237	10.80	26.80
6	6.625	0.280	19.00	15.20
8	8.625	0.322	28.60	10.10
10	10.750	0.365	40.50	7.13
12	12.750	0.375	49.60	5.82
14	14.000	0.375	54.60	5.29
16	16.000	0.375	62.60	4.61
18	18.00	0.375	70.60	4.09
20	20.000	0.375	78.60	3.68
22	22.000	0.375	86.60	3.34
24	24.000	0.375	94.60	3.06
26	26.000	0.375	102.60	2.82
28	28.000	0.375	110.60	2.62
30	30.000	0.375	118.70	2.44
32	32.000	0.375	126.60	2.28
34	34.000	0.375	134.60	2.15
36	36.000	0.375	142.60	2.03

Table 4
Estimated Resistance of Steel Pipelines

6.13.3.1 This data is then applied to the following formula:

$$\text{Current} = \frac{\text{mV IR Drop}}{\text{Resistance}}$$

The direction of the current flow is determined from the polarity of the mV IR drop reading measured. For example using Figure 35, a positive IR drop indicates current flow from right to left, while a negative IR drop would indicate current flow from left to right.

6.13.4 MULTI-COMBINATION METER. The multi-combination meter has the capability of measuring current by the “Null Ammeter Method.” This meter can safely measure line currents less than two amps. Do not use this method in areas over two amps of line current. Stray current variations or other fluctuations in the measurement may make keeping the meter nulled to obtain an accurate and reliable measurement too difficult. This method does not require any information on the length of the test span, diameter of the structure, or the type of metal being tested.

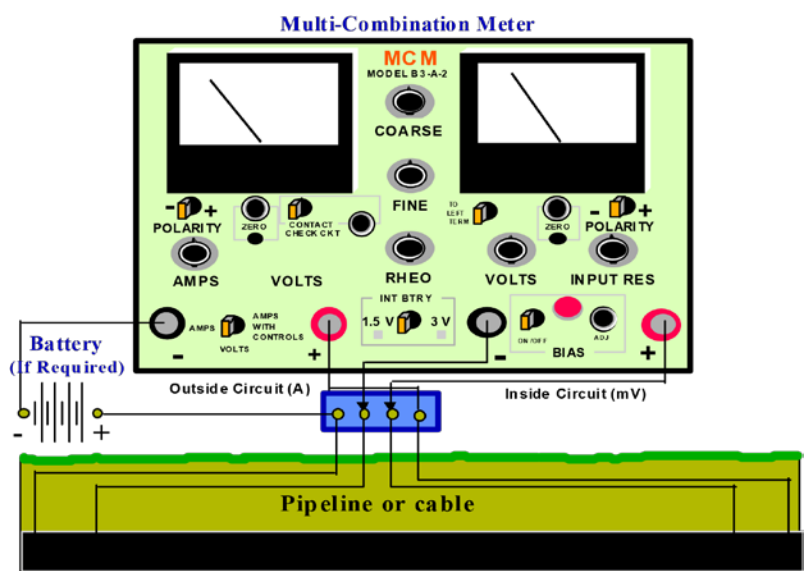

Figure 36

Null Ammeter Method, Using the Multi-Combination Meter

6.14 INTERFERENCE TESTING PROCEDURES. When current flows through an electrolyte, it follows the path of least electrical resistance. If a metal structure is immersed in the current-carrying electrolyte, it is likely to present a low resistance path for the flow of current. At the point where electrons enter the structure from the electrolyte, corrosion will be accelerated. Where electrons leave the structure, corrosion will be reduced. This phenomenon is called cathodic interference. Cathodic interference is

commonly encountered on buried structures. Cathodic interference can be detected by electrical measurements and can be controlled. Cathodic protection sometimes causes undesirable effects on structures not connected to the protection system. This occurs because some current is picked up by these “foreign” structures at one point, and in attempting to return to the source and complete the circuit, is discharged at another point. Corrosion occurs at the current discharge point. Current can cause corrosion damage by passing between two structures or across high-resistance joints in the same structure. Sources of interference currents may be constant or fluctuating. Constant current sources have essentially constant direct current output, such as cathodic protection rectifiers and thermoelectric generators. Fluctuating current sources have a fluctuating direct current output, such as direct current electrified railway systems, coal mine haulage systems and pumps, welding machines, direct current power systems, and telluric currents.

Mitigation can usually be accomplished by installing an electrical bond between the unprotected structure (at the location of maximum discharge) and the protected structure. Other mitigation methods include breaking the continuity of the foreign pipeline, coating the foreign pipeline pickup area, coating the protected pipeline in the discharge area of the foreign pipeline, and using galvanic anodes to apply current to the discharge area of the foreign pipeline (and also provide an alternate current discharge point).

6.14.1 INTERFERENCE FROM CATHODIC PROTECTION RECTIFIERS. Cathodic protection systems are a major source of stray current on other metallic structures. Structures not electrically connected to the protected structures are considered to be “foreign” structures.” A foreign structure may provide an alternate path for the current flowing from the impressed current anodes to a protected structure. If this path is of sufficiently low resistance, significant current flow will occur. Since there is no metallic return path, the current will discharge from the surface of the foreign structure to the electrolyte to return to its source, resulting in severe corrosion.

Testing requires cooperation by the owners of the structures involved. Such cooperation is best effected by a corrosion coordinating committee; all companies operating

underground or underwater structures, and particularly those under cathodic protection, should be members of such a committee. A list of most existing committees may be obtained from the National Association of Corrosion Engineers, P.O. Box 218340 Houston, TX, 77218-8340. Interference testing is usually performed when new cathodic protection systems are first installed but is sometimes detected through routine field measurements. Good record keeping is very useful in preventing cathodic interference problems, as any system changes, particularly additions of new buried structures, can be more easily determined when proper records are kept. Interference tests must be made on all structures adjacent to a cathodic protection system to determine effects and to allow design of mitigation measures.

Cathodic interference can be detected by measuring structure-to-soil potentials, potential gradients and current flow (IR drop) with cathodic protection current or resistance bonds on and/or cycled on and off. Structure-to-soil potentials give indications of interference only when measured in an area of current discharge or pickup on the foreign structure. Abnormal or unusual current distribution on a protected structure indicates possible interference on a foreign structure. Current flow (IR drop) readings show the relationship between pickup and discharge areas on a foreign structure. A cathodic protection rectifier output contains a waveform, which results in a pulsating DC signal. Presence of this pulsating DC on foreign structures indicates interference from a rectifier. When conducting current requirement tests or initially energizing impressed current cathodic protection systems, all companies owning underground structures in the area should be notified and coordination tests made with those interested. Current drainage requirements for each structure, from tests at various anode locations, can be determined.

The best method to locate interference is to perform a pipe-to-soil potential survey of the foreign pipeline with the source of the interference cycled on and off at specific intervals. The algebraic difference between the “on” and “off” reading (potential shift) gives the interference effect on the foreign structure. The location showing greatest pipe-to-soil potential change in the positive (“unprotected”) direction is called the “critical” or “control” point. This is often at the point where protected and unprotected pipelines cross. The

areas showing pipe-to-soil potential change in the negative (“protected”) direction are called “pickup” areas. Presence of a pickup area on a foreign structure indicates that interference is present, and a discharge area exists somewhere on that structure. If metallic continuity exists between the foreign structure and the negative terminal of the rectifier, this is not interference, it is protection, and no discharge area exists (and therefore, by definition is not a foreign structure).

If the source of the cathodic interference is not known, it can be detected by measuring structure-to-soil potentials with the cathodic protection current on and by measuring potential gradients. Structure-to-soil potentials give indications of interference only when measured in an area of current discharge or pickup on the foreign structure.

Potential gradients are measured by the cell-to-cell test procedures. Taking these measurements along the foreign pipeline may locate the discharge point and pickup areas. The polarity must be ascertained to determine the direction of current flow and magnitude. Current will flow in the direction of the discharge point. The magnitude will increase as you near the discharge point. The direction will reverse upon passing a discharge point. The reversal with the highest magnitude is the “control” or “critical” point. The discharge point is usually near the structure, which is causing the interference. The pickup area is usually near the anode system, which is causing the interference. Locating the pickup area is important in locating the source of the interference, since it shows the direction that the current is coming from.

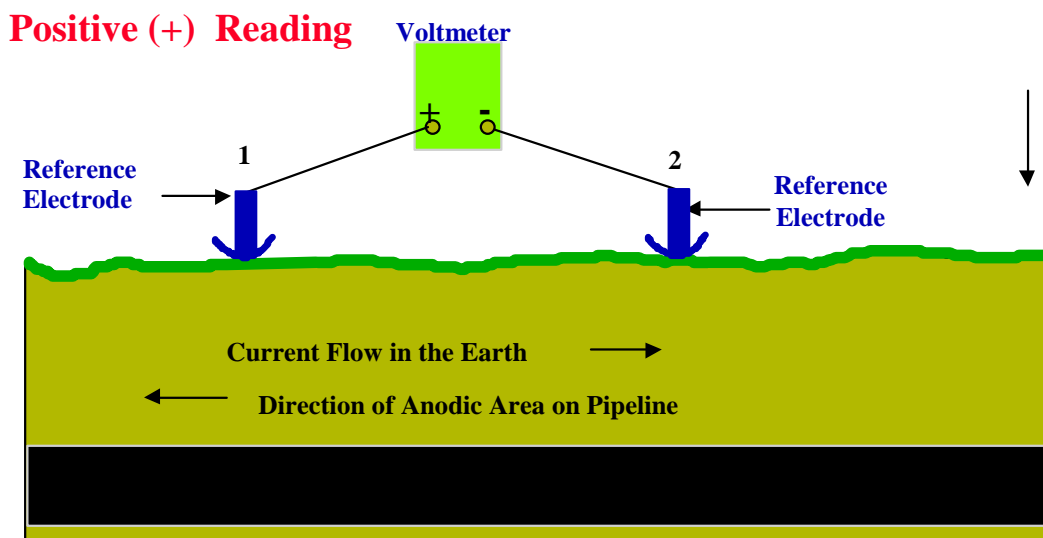

Figure 37

Cell-To-Cell Polarity on Foreign Structure

Measurement of the current flow (IR drop) on a foreign pipeline can be accomplished if other methods are inconclusive. Current flow (IR drop) readings show the relationship between pickup and discharge areas on a foreign structure. By measuring the current flow on a foreign structure, the direction of the discharge point and pickup areas can be determined. Magnitude indicates seriousness, and increases as the distance to the discharge point decreases. These measurements can be easily accomplished if IR drop test stations already exist or if the pipeline is accessible (comes aboveground or passes through pits). Current is measured at an IR drop test station by the procedures detailed. Current is measured where access to the pipeline is possible using a clamp-on milliammeter (such as the Swain CP AmpClip). The correct size clamp must be used for the pipeline under test. Note: typical clamp-on meters do not work in this application. It must be capable of measuring DC amps, with a range capable of accurate measurement of under 30 milliamps.

Abnormal or unusual current distribution on a protected structure indicates possible interference on a foreign structure. Normally, the potential of a protected structure decreases slightly as distance from the anodes increases. At defects in coatings, the potential of a protected structure decreases. An increase in potential normally indicates

current pickup. If the potential of a protected pipeline increases when crossing a foreign pipeline, interference is likely on that structure. Potential survey of that structure while interrupting the source of current will indicate the presence and magnitude of that interference.

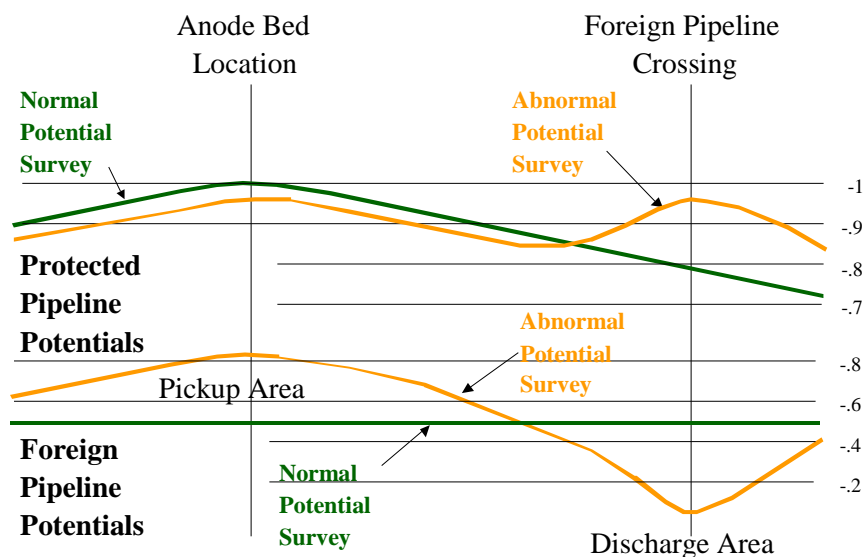

Figure 38

Normal and Abnormal Potentials of Protected and Foreign Pipelines
Potential Survey of Pipelines for Interference

A cathodic protection rectifier output contains a waveform, which results in a pulsating DC signal. This signal can be located using a pipe locator capable of following a 120 cycles per second signal (such as the Pipe Horn, Model 200 FDAC, in rectifier mode). Presence of this signal indicates presence of interference on the foreign structure. Combining this method with a current interrupter on suspected sources of the interference will quickly locate the source of the interference. Signal strength can sometimes be used to indicate the direction of the discharge and pickup areas. Normally, signal strength will increase in the direction of the discharge point. This may not occur with multiple discharge areas.

Another method of interference testing involves using an experimental drainage bond between structures. Proper drainage can be determined by trial-and error, using a variable resistor to alter drainage current. Required drainage current can also be computed from test data. When the same owner maintains the protected structure and the foreign structure, this method may be easily used. The source of interference is cycled on and off at specific intervals and the bond resistance is adjusted until no potential shift occurs on the foreign structure. When site conditions warrant, the bond may be sized to apply partial or full protection to the foreign structure. If the foreign structure is small or well coated, and the protected structure is poorly coated, this option may be taken when sufficient CP current is still available to maintain protection on the protected structure.

6.14.2 INTERFERENCE FROM VARIABLE (FLUCTUATING) SOURCES. While interference testing determines effects of steady stray currents, another type of stray current survey analyzes fluctuating stray currents. Fluctuating or periodic changes in structure-to electrolyte voltage values and unusual or fluctuating currents are indicative of stray currents. Stray currents may affect structures just as cathodic protection does. Structures may be protected or damaged by stray currents, depending on whether current is flowing to or from the structure. Such analysis is specialized and requires study to master all techniques. The basic principles are the same as in the previous paragraph. The difference is that the stray current is not present all the time. The simultaneous use of data loggers or recording devices at many points on the foreign structure will indicate the same information as above. Locating the discharge point(s) and pickup areas is still crucial. In this case, determining the time of the interference is also crucial.

All the basic measurements can be used in studying fluctuating stray currents. Perhaps the most informative are measurements similar to those used in interference testing: structure-to-electrolyte potentials and IR drops along structure or electrolyte. Methods of analysis, however, are different, and specialized equipment is used. The major concern in performing a stray current survey is to find out the degree of damage and determine the source of the currents.

Measurement of the foreign pipeline potentials is commonly used to determine the pickup and discharge areas. Using data loggers or recording devices, many locations on the foreign structure are monitored simultaneously. This data is then charted to analyze for the presence of interference. When the exact moment of interference is determined, all potential readings taken at that instant are used to determine the discharge and pickup points. Data taken is used to locate areas for taking additional data. Once gathered, this data is used exactly like the data for cathodic interference detailed. Abnormal potentials on other structures may also be used for further analysis. Once the pickup area and time is determined, the source of the current may be located.

Another method of finding these points is through current measurements. To determine the pickup and discharge points in fluctuating stray current areas, data from several test points are plotted over a period of time. Current values on the several locations on the foreign structure (recorded from IR drop test spans or a clamp-on milliammeter) are plotted over a period of time. The current must be measured at several points simultaneously, sufficient readings being made to cover the range of variation of the current (usually at least 24 hours). By analyzing the current direction and magnitude at the time the interference is occurring, the relationship and direction of the pickup areas and discharge areas can be determined. Once the time of interference is known, the area of pickup can be searched for possible sources of the current pickup. Outside of the necessity of taking simultaneous readings due to the fluctuating current, this method is the same as conventional line current measurements.